

ON Semiconductor

Is Now

onsemi™

To learn more about onsemi™, please visit our website at
www.onsemi.com

onsemi and **onsemi** and other names, marks, and brands are registered and/or common law trademarks of Semiconductor Components Industries, LLC dba "**onsemi**" or its affiliates and/or subsidiaries in the United States and/or other countries. **onsemi** owns the rights to a number of patents, trademarks, copyrights, trade secrets, and other intellectual property. A listing of **onsemi** product/patent coverage may be accessed at www.onsemi.com/site/pdf/Patent-Marking.pdf. **onsemi** reserves the right to make changes at any time to any products or information herein, without notice. The information herein is provided "as-is" and **onsemi** makes no warranty, representation or guarantee regarding the accuracy of the information, product features, availability, functionality, or suitability of its products for any particular purpose, nor does **onsemi** assume any liability arising out of the application or use of any product or circuit, and specifically disclaims any and all liability, including without limitation special, consequential or incidental damages. Buyer is responsible for its products and applications using **onsemi** products, including compliance with all laws, regulations and safety requirements or standards, regardless of any support or applications information provided by **onsemi**. "Typical" parameters which may be provided in **onsemi** data sheets and/or specifications can and do vary in different applications and actual performance may vary over time. All operating parameters, including "Typicals" must be validated for each customer application by customer's technical experts. **onsemi** does not convey any license under any of its intellectual property rights nor the rights of others. **onsemi** products are not designed, intended, or authorized for use as a critical component in life support systems or any FDA Class 3 medical devices or medical devices with a same or similar classification in a foreign jurisdiction or any devices intended for implantation in the human body. Should Buyer purchase or use **onsemi** products for any such unintended or unauthorized application, Buyer shall indemnify and hold **onsemi** and its officers, employees, subsidiaries, affiliates, and distributors harmless against all claims, costs, damages, and expenses, and reasonable attorney fees arising out of, directly or indirectly, any claim of personal injury or death associated with such unintended or unauthorized use, even if such claim alleges that **onsemi** was negligent regarding the design or manufacture of the part. **onsemi** is an Equal Opportunity/Affirmative Action Employer. This literature is subject to all applicable copyright laws and is not for resale in any manner. Other names and brands may be claimed as the property of others.

TND6327/D

3.3 kW APM OBC Demo Board Test Report



ON Semiconductor®

www.onsemi.com

SPECIFICATION

Device Series	Application	Input Voltage	Output Power	Topology	I/O Isolation
FAN9672Q, NCV4390, NCV3843B, FAN3224TUMX-F085, NCV890100PDR2G, NCV51460SN33T1G, NCV210SQT2G, NCV2003SN2T1G, SC431AVSNT1G FODM8801C, ...	On Board EV Charger	90~264 Vac	3.3 kW	2CH Interleave PFC + Full Bridge LLC + Flyback + Buck DCDC	Yes

REFERENCE DESIGN

OTHER SPECIFICATION

	Output
Output Voltage	200 – 420 Vdc
Ripple	5% (Meet QCT 895 2011)
Nominal Current	-
Max Current	10 A
Min Current	0

PFC (Yes/No)	Yes
Minimum Efficiency	90%
Inrush Limiting	24 A
Operating Temperature Range	-20 – 85°C
Cooling Method	Force Air or Liquid cooling. Depend on the Heatsink
Signal Level Control	On/Off, CC, CV



Prototype

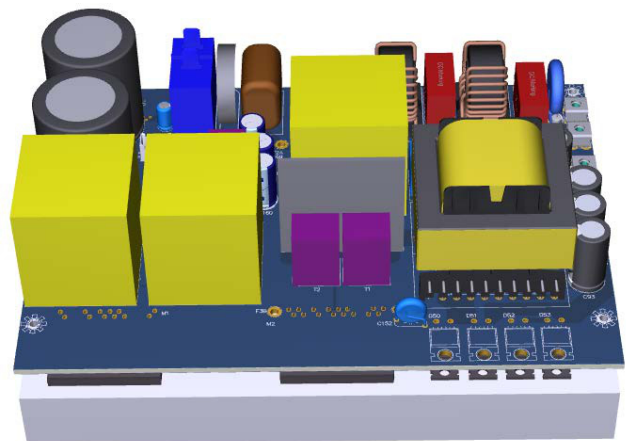

3D Model

Figure 1. Photograph of the Evaluation Board

TND6327/D

KEY FEATURES

Whole Solution

- 2CH Interleave PFC to get high efficiency and power density. Decrease the current ripple at mean time
- Full bridge LLC to boost efficiency by high bus voltage usage
- Flyback topology to supply as auxiliary power
- Hardware PFC and LLC control approach for easily designing and less malfunction.
- Full functional solution including input/output current/voltage sensing and CC/CV PWM control interface.
- AEC-Qualified APM to decrease PCB space and increase power density

PFC Controller FAN9672

- Continuous Conduction Mode with Average Current Mode Control
- Two-Channel Interleave Operation
- Programmable Operation Frequency Range: 18 kHz~40 kHz or 55 kHz~75 kHz
- Programmable PFC Output Voltage
- Two Current-Limit Functions
- TriFault Detect Protects Against Feedback Loop Failure
- SAG Protection
- Programmable Soft-Start
- Under-Voltage Lockout (UVLO)
- Differential Current Sensing

LLC Controller NCV4390 (AEC Qualified Version of FAN7688)

- Secondary Side PFM Controller for LLC Resonant Converter with Synchronous Rectifier Control
- Charge Current Control for Better Transient Response and Easy Feedback Loop Design

- Adaptive Synchronous Rectification Control with Dual Edge Tracking
- Closed Loop Soft-Start for Monotonic Rising Output
- Wide Operating Frequency (39 kHz~690 kHz)
- Green Functions to Improve Light-Load Efficiency
- Symmetric PWM Control at Light-Load to Limit the Switching Frequency while Reducing Switching Losses
- Protection Functions (with Auto-Restart
 - ◆ Over-Current Protection (OCP)
 - ◆ Output Short Protection (OSP)
 - ◆ NON Zero-Voltage Switching Prevention (NZS) by Compensation Cutback (Frequency Shift)
 - ◆ Power Limit by Compensation Cutback (Frequency Shift)
 - ◆ Overload Protection (OLP) with Programmable Shutdown Delay Time
 - ◆ Over-Temperature Protection (OTP)
- Programmable Dead Times for Primary Side Switches and Secondary Side Synchronous Rectifiers
- VDD Under-Voltage Lockout (UVLO)
- Wide Operating Temperature Range -40°C to +125°C

PWM Controller NCV3843

- Trimmed Oscillator for Precise Frequency Control
- Oscillator Frequency Guaranteed at 250 kHz
- Current Mode Operation to 500 kHz
- Automatic Feed Forward Compensation
- Latching PWM for Cycle-By-Cycle Current Limiting
- Internally Trimmed Reference with Undervoltage Lockout
- High Current Totem Pole Output
- Undervoltage Lockout with Hysteresis
- Low Startup and Operating Current

SCHEMATICS AND CIRCUIT DESCRIPTION

The system diagram is on Figure 2. The key elements of the OBC are marked in the color blocks.

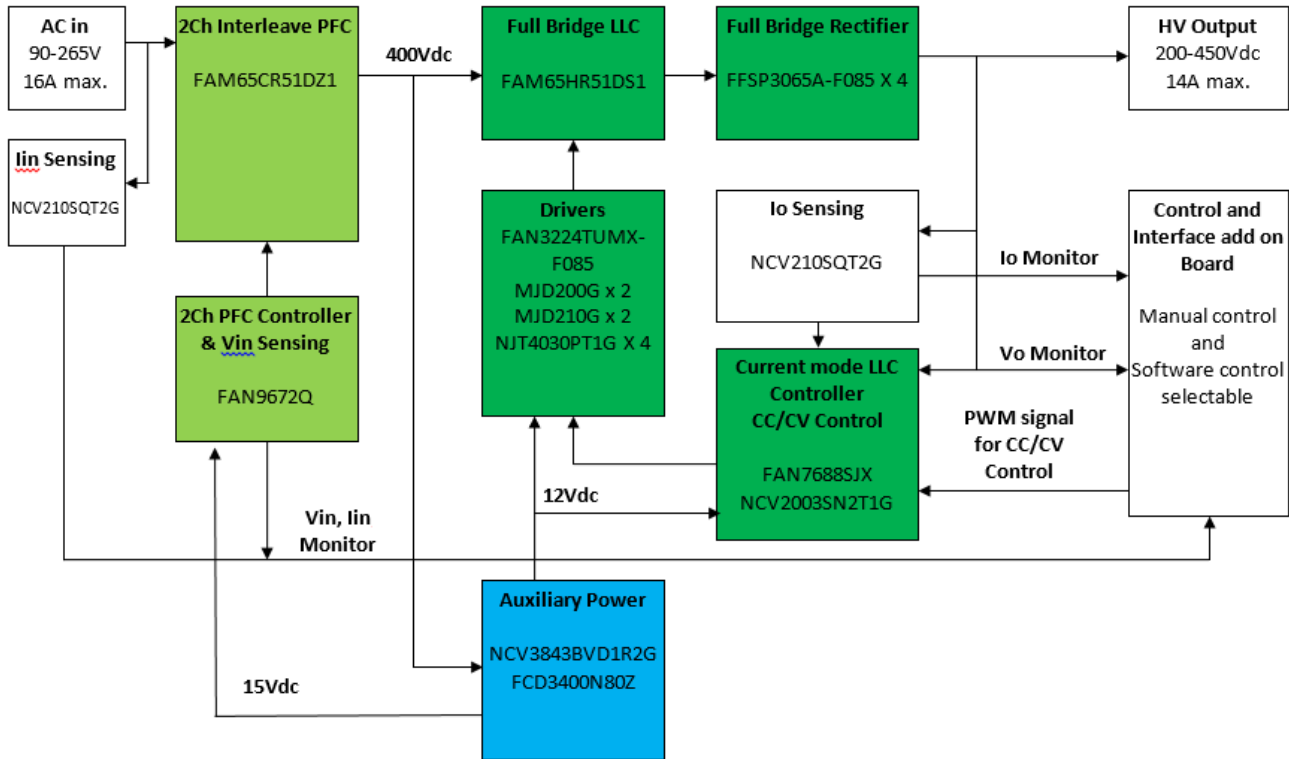

Figure 2. System Diagram of the 3.3 kW APM OBC

Following the AC input is the PFC stage. It's marked in light green. The detail schematic is shown on Figure 3. The key elements of the PFC stage are the controller FAN9672 and the dual boost power devices. They are in the right side of the Figure 3. More details of the FAN9672 please refer the datasheet and the application notes of the device on the web

site <https://www.onsemi.cn/PowerSolutions/product.do?id=FAN9672>. Among others, to avoid the CS+ signals are short circuit equivalent by C42 and C43, we placed the decouple inductors L21 and L31 on the Vcc of the Totem poles.

TND6327/D

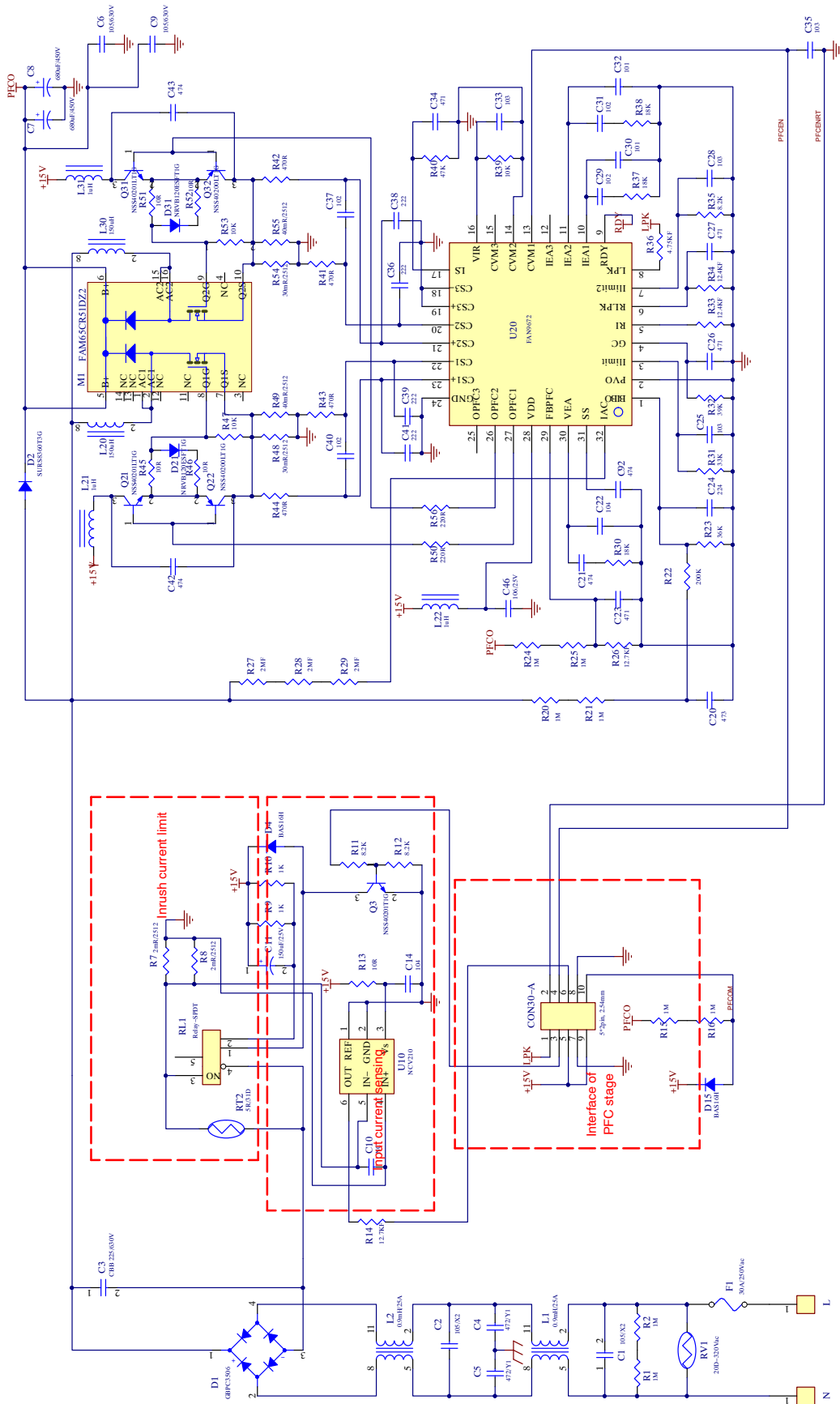

Figure 3. Schematic of the PTC

TND6327/D

The middle block is the input current sensing circuit. The standard of the OBC required the input current must be under a safety level to prevent the power cord and the connector overheat in every condition. So the charger system must monitor the input current continually. If the input current over the limit by the reason of the input voltage get lower or any others, the system must decrease the output power. The U10 is the 200X fix-gain current sense

amplifier. Co-operate with the R7 and R8, the voltage on pin6 of U10 will be $200 \times 0.001 \times I_{in}$. If $I_{in} = 16$ Arms, at peak point of the sin wave, the output of U10 is 4.525 V.

The lower block is the interface of the PFC stage. The 10 pin connector CON30 connects the PFC stage to the interface board. The Table 1 shows the signals on the CON30.

Table 1. SIGNALS OF THE CON30

Pin No.	Direction	Description
1	Output	Input voltage sensing.
2	-	Return of PFC enable signal. Connect to GND of FAN9672 in differential path with Pin 5.
3	Input	Relay Control signal.
4	Input	PFC enable signal. Control CM1 of FAN9672.
5	Output	+18V.
6	Output	Input current sensing signal.
7	-	GND
8	-	GND
9	Input	+18V.
10	Output	PFC output voltage sensing.

Another key element of the OBC is the DCDC stage. It was marked in dark green in Figure 2. The schematic of the DCDC stage is shown in Figure 4. We adopt the full bridge LLC topology to get the high efficiency and suitable cost. It composed by U60 and M2 etc. The FAN7688 (U60) is a current mode advanced LLC controller. More details of the FAN7688 please refer the datasheet and the application notes on the web site <https://www.onsemi.cn/PowerSolutions/product.do?id=FAN7688>. Because of the high output

voltage (200 – 420 Vdc), the Synchronous Rectifier cannot help too much on the rectifier conduction loss. So we omitted the SR function of the FAN7688. Find a suitable power transformer and resonate inductor on the 3 kW power level is not easy. We used EPCOS's PQ50 PTH to make the main transformer and adopted PQ4040 as the resonant inductor. They were performance well in the thermal test under the wide output voltage conditions.

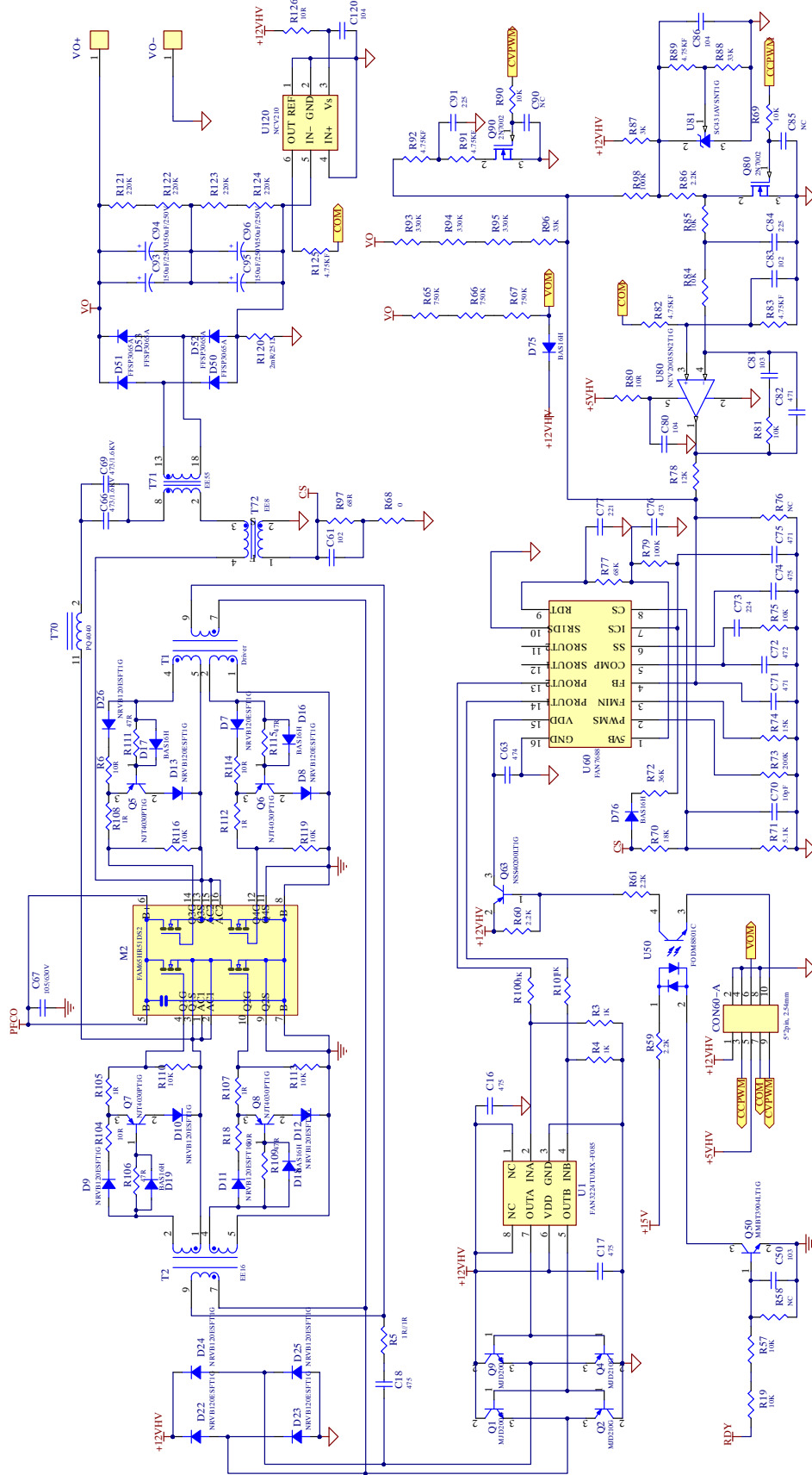

Figure 4. Schematic of the DC-DC

Driving the full bridge MOSFETs with the half bridge LLC controller like FAN7688 is not difficult. Just drive the diagonal MOSFETs by the same signal is okay. To drive the low R_{ds(on)} MOSFETs need strong driver ability. The PROUT signals of FAN7688 amplified by the U61 (FAN3224) and expend the current driving ability by the totem pole (Q1, Q2, Q4, Q9) then delivery to primary side trough pulse transformers T1 and T2. Emitter followers Q5 – Q8 are to speed up the turning off of the MOSFETs.

The FAN7688 integrated a voltage reference and an error amplifier inside. For the CV (Constant Voltage) control, we just follow the typical application of the FAN7688 is okay. What we need to do in the OBC application is just to add a CC (Constant Current) control loop. The U80 rail to rail amplifier and peripheral components acted as this role. During the CV mode, the U80 is in saturation. The voltage drops on the output of U80 can be ignored. On the close loop state, the output voltage determined by the voltage dividing resistors (R93, R94, R95, R96, R78, R91 and R92. We ignore the effect of R98 here for easy calculation) and the PWM

duty of CV control signal CVPWM. If CVPWM duty = 100%, the output voltage will be $2.4 \times \{R93 + R94 + R95 + R96 + [R78 // (R91 + R92)] / [R78 // (R91 + R92)]\}$. And if the CVPWM duty = 0, the output voltage will be $2.4 \times (R93 + R94 + R95 + R96 + R78) / R78$. Fill the value of the resistors; the output voltage will change from 420 V to 200 V if the CVPWM duty decreases from 100% to 0. The purpose of R98 is to add a small bias voltage on the FB pin. Without it the current on the resonant tank may increase too fast during the start-up moment and trigger the over current protection. The R98 is also makes the output voltage lower a little bit than we calculate above. Please make an alignment on whichever of R93, R94, R95, R96 or R78 if necessary.

The circuit around the U120 and R124 is to sense the output current. It's quite same with the block of U10 which we discussed above. CON60 is the interface of the DCDC stage. The Table 2 shows the signals on the CON60.

The FAN7688 get VDD when both of the PFC RDY and the LLC enable signal are active.

Table 2. SIGNALS OF THE CON60

Pin No.	Direction	Description
1	Output	+12VHV.
2	–	GND
3	Input	CCPWM. PWM signal for constant current setting.
4	–	GND
5	Input	+5VHV.
6	Output	VOM. Output voltage sensing.
7	Output	COM. Output current sensing.
8	–	GND
9	Input	CVPWM. PWM signal for content voltage setting.
10	Input	LLC enable signal.

The third key element of the OBC is the Auxiliary power. Figure 5 show the schematic.

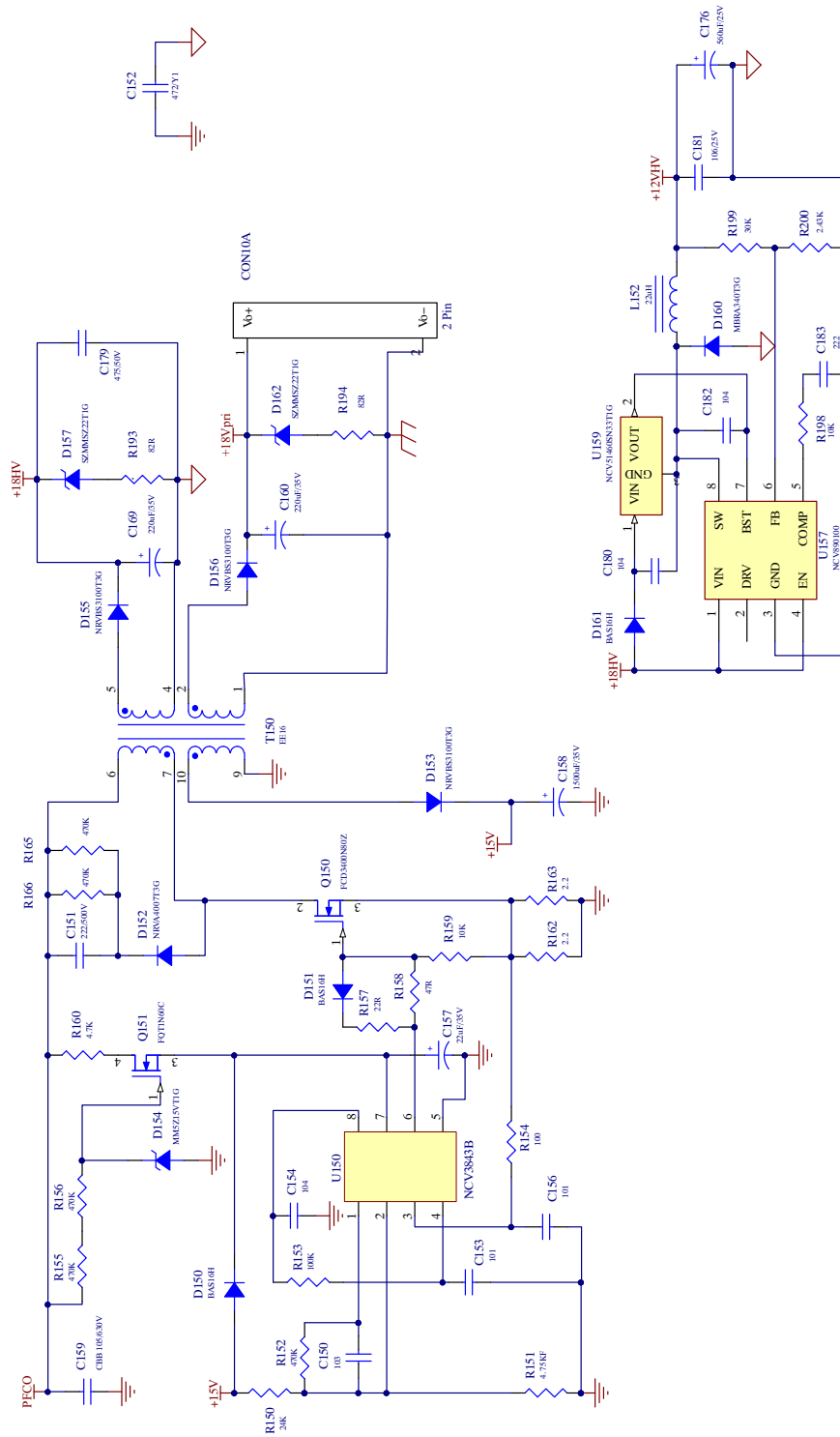

Figure 5. Schematic of the Low Voltage and Auxiliary Power

The main topology of the auxiliary power is fly-back. We adopted NCV3843BVD1R2G as the controller due to the circuit was simple and it was AEC qualified. You can find the detail of the datasheet and application note about the PWM controller NCV3843BVD1R2G on our website: <http://www.onsemi.com/pub/Collateral/NCV3843BV-D.PDF>.

This OBC has 3 separate GNDs. They are primary GND, LV output GND, and HV output GND. They are isolating each other. The can bus connect to LV GND. The DCDC controller connects to HV GND. Besides the LV output, the fly-back converter also provides the Vcc to PFC and DCDC controllers. So it has 3 isolating outputs. The feedback output of the PWM controller is the Vcc for the PSR control. To avoid the voltage of +18VHV too high on heavy load situation, we placed the active dummy load on the output. It's D157 and its peripheral components. The dummy load can adjust the load current according to the output voltage automatically then save the power loss during the LV output light load moment.

Due to the LLC controller need the relative regulate Vcc for stable operating. The +18VHV output cannot meet regulation requirement due to the LV output's uncertainty. So the sub-regulator is necessary. For efficiency reason, we select the buck converters made by NCV890100PDR2G. This is a non-SR buck switching regulator with SO8-EP package. The switching frequency is up to 2 MHz. The performance cost ratio is high and easy for application.

On the typical application circuit of NCV890100, the Bootstrap is powered by the internal 3.3 V regulator. This method has a problem on this OBC design. In case of the load of LV is very light, the voltage of +18VHV will drop and

close to 15 V and 12 V. The duty of the buck converter will be very large. Then the bootstrap voltage will drop below the DRV POR Stop Threshold and the device stop working. To solve this problem we connect the bootstrap diodes (D161) to Vin of the buck converters instead of the DRV pin. And insert a 3.3 V LDO (U159) from the bootstrap voltage to BST pin.

This way extends the maxima duty range of the converter. And if the device stops working by Vin drop, once the $V_{in}-V_o$ goes up to 3.3 V, the device will re-work again. But in the typical application circuit, if the device stops working, It will keep stop until the V_o drop to 0 V.

The connector CON10 deliveries the +18Vpri voltage to the interface board.

In this design, we put the interface circuits on an add-on board for the flexibility. The features of the full function interface board will include the (1) Can communication with the BMS system to report the information like: Input voltage, Input current, Output voltage, Output current, Bus voltage, Output miss-connection, LV voltage, Temperature of the Bridge Rectifier, Temperature of the PFC MOFETs and Diodes, Temperature of the PFC Inductors, Temperature of the LLC transformers, Temperature of the LLC Diodes. (2) Can communication with the BMS to receive the following command: Power-up, Output voltage, Output current, Power off. (3) Output the CC, CV PWM signals and the power-on and relay-on signals to the main board. But, the full function interface board is not ready so far. We use a simple manual control board instead of the full function one. Figure 6 show the schematic of the manual control interface board.

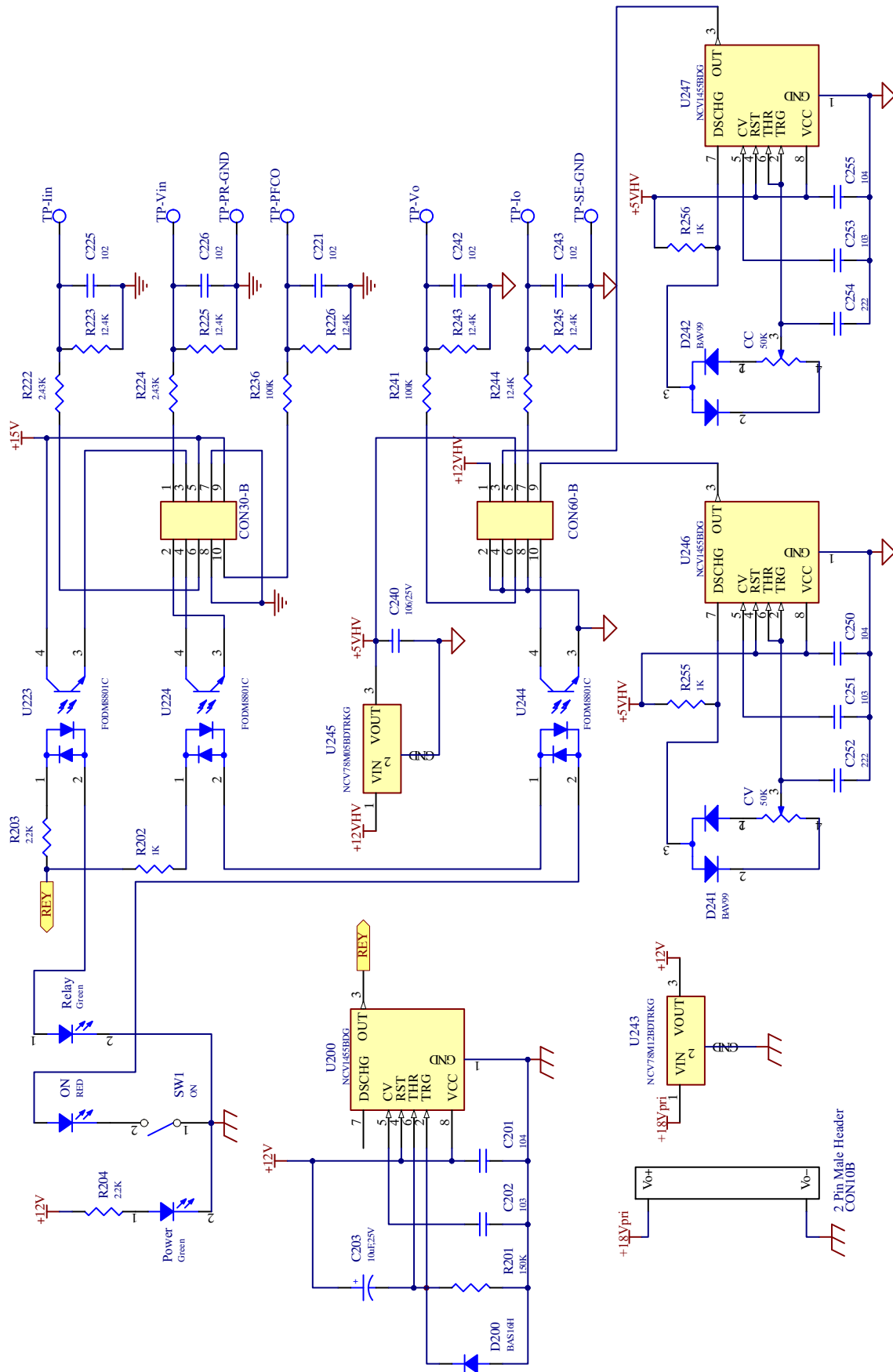

Figure 6. Schematic of the Manual Control Interface Board

TND6327/D

The SW1 powers ON/OFF the PFC and LLC stage in the secondary side for safety. It is delivery to the primary and HV stage by U223 and U224. The Vcc of the U223 and U224 is powered by the REY signal, thus the power-up will be AND with the relay active. The REY signal is 3 second delayed by U200 from the 12 V LV active moment to

guarantee the Bus Caps is full charged. The CC and CV PWM signals are generated by the U246 and U247 and the peripherals components. The variable resistors CC and CV control the duty of the PWM signals. The sensing signals like Vin, Iin, Vbus, Vo and Io was connected to the test points for customer testing by the voltage meter.

TND6327/D

MEGNATICS DESIGN DATA SHEET

PFC Inductors: L20, L30. WE part no.: 750343941

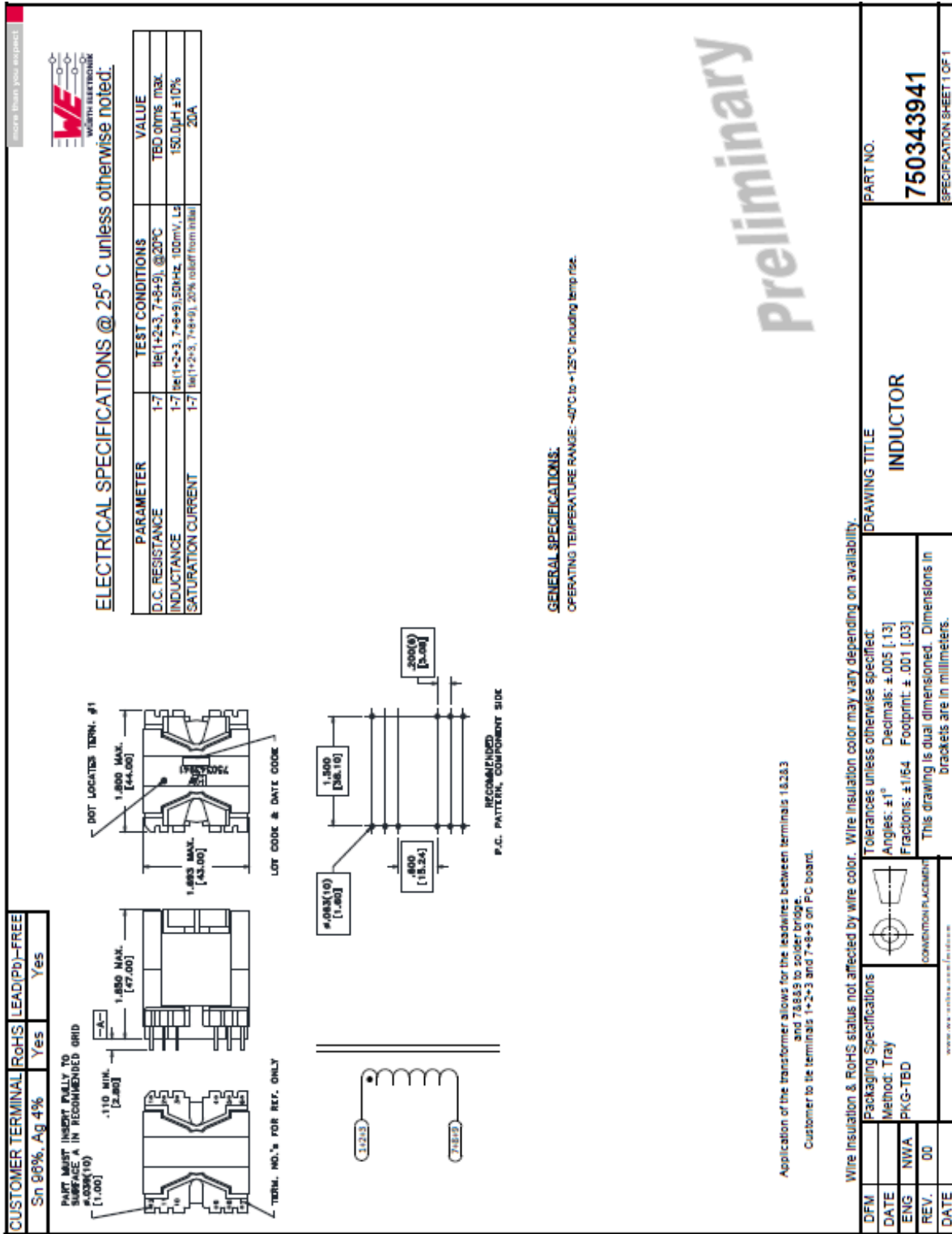

Figure 7.

Auxiliary Transformer: T150. WE part no.: 750344081

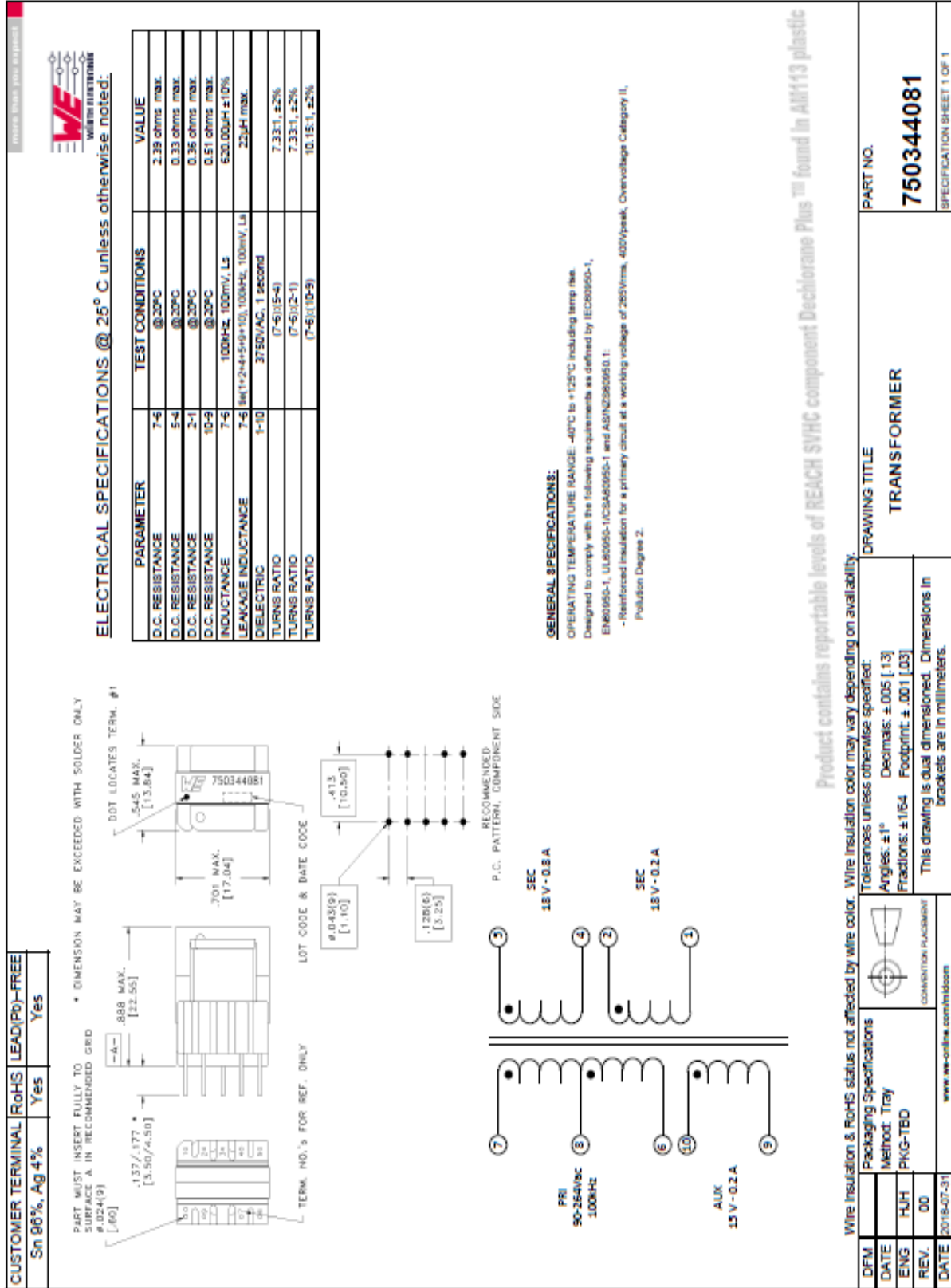

Figure 8.

Pulse Transformer: T1, T2. WE part no.:750344082

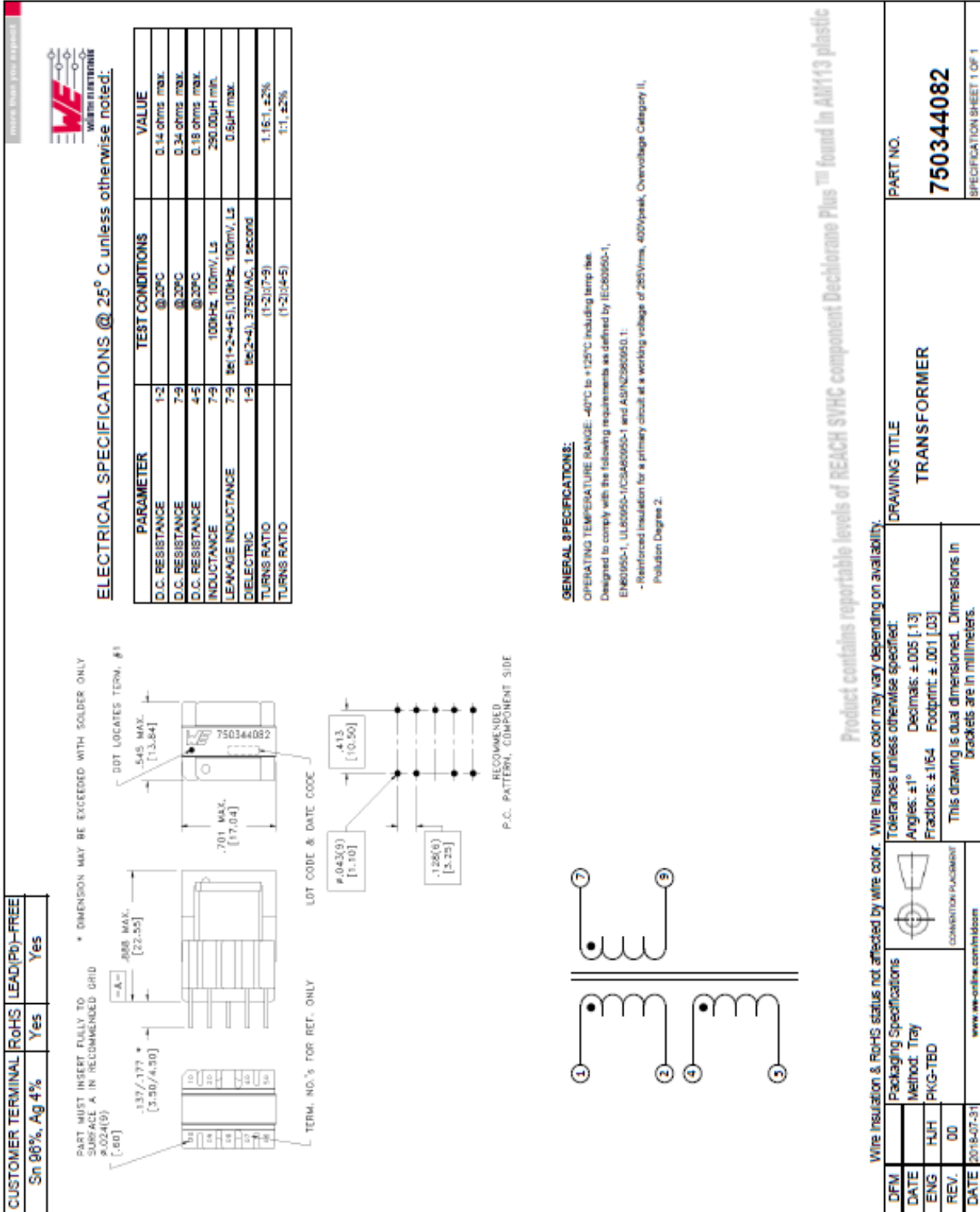
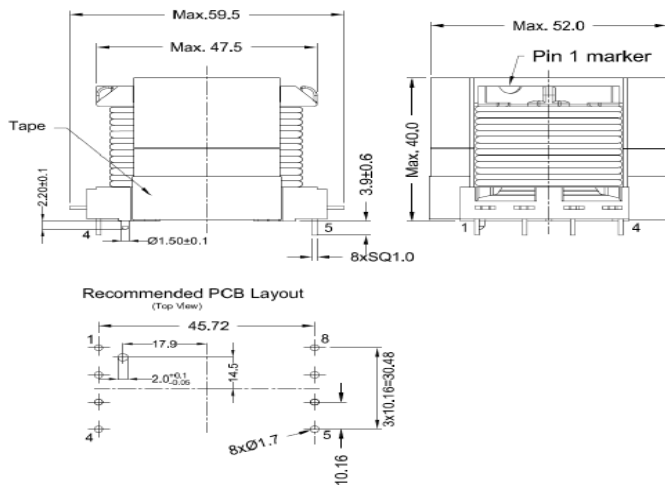

Figure 9.

TND6327/D

LLC Main Transformers: T71. TDK Ordering code:
P301039-A1-55



Circuit diagram

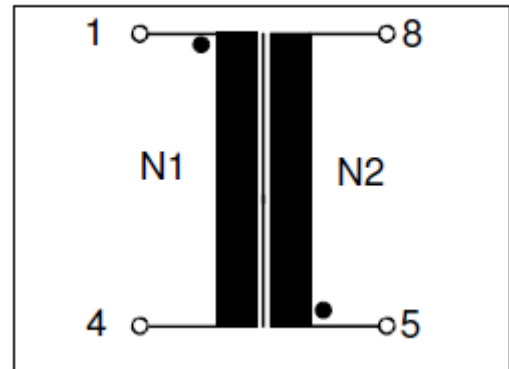

Technical data and measuring conditions

specified @ 25°C if not mentioned otherwise, all values without tolerance are typical values

Inductance L	280 μ H \pm 10% measured at terminals [1, 4], measuring conditions 100 kHz, 100 mV
Turns ratio N1 : N2	1 : 0.94
Leakage Inductance LL	1.70 μ H measured at terminals [1 - 4], measuring conditions 100 kHz, 100 mV, short pins 5-8
DC resistance, primary $R_{DC, N1}$	22.5 m Ω measured at terminals [1, 4]
DC resistance, secondary $R_{DC, N2}$	21.0 m Ω measured at terminals [5, 8]
High voltage: N1 - N2	2500 V, 50 Hz, 1 s
High voltage: N1 - core	2500 V, 50 Hz, 1s
High voltage: N2 - core	2500 V, 50 Hz, 1s
Switching frequency	100 kHz
Power (output)	3300 W
Operating temperature range	-40°C / 150°C (component)
Weight	Approx. 245 g

Construction

- PQ50/40 ferrite core
- Winding: Litz wire (TW)

Features

- Qualified to AEC-Q200
- RoHS compatible
- Insulation between primary and secondary side:
creepage distance min. 6.0 mm
clearance distance min. 5.5 mm
material CTI < 400

Applications

- Transformer for on board charging used in hybrid or electrical vehicles

Figure 10.

LLC Resonant inductor: T70. WE part no.: 750343716

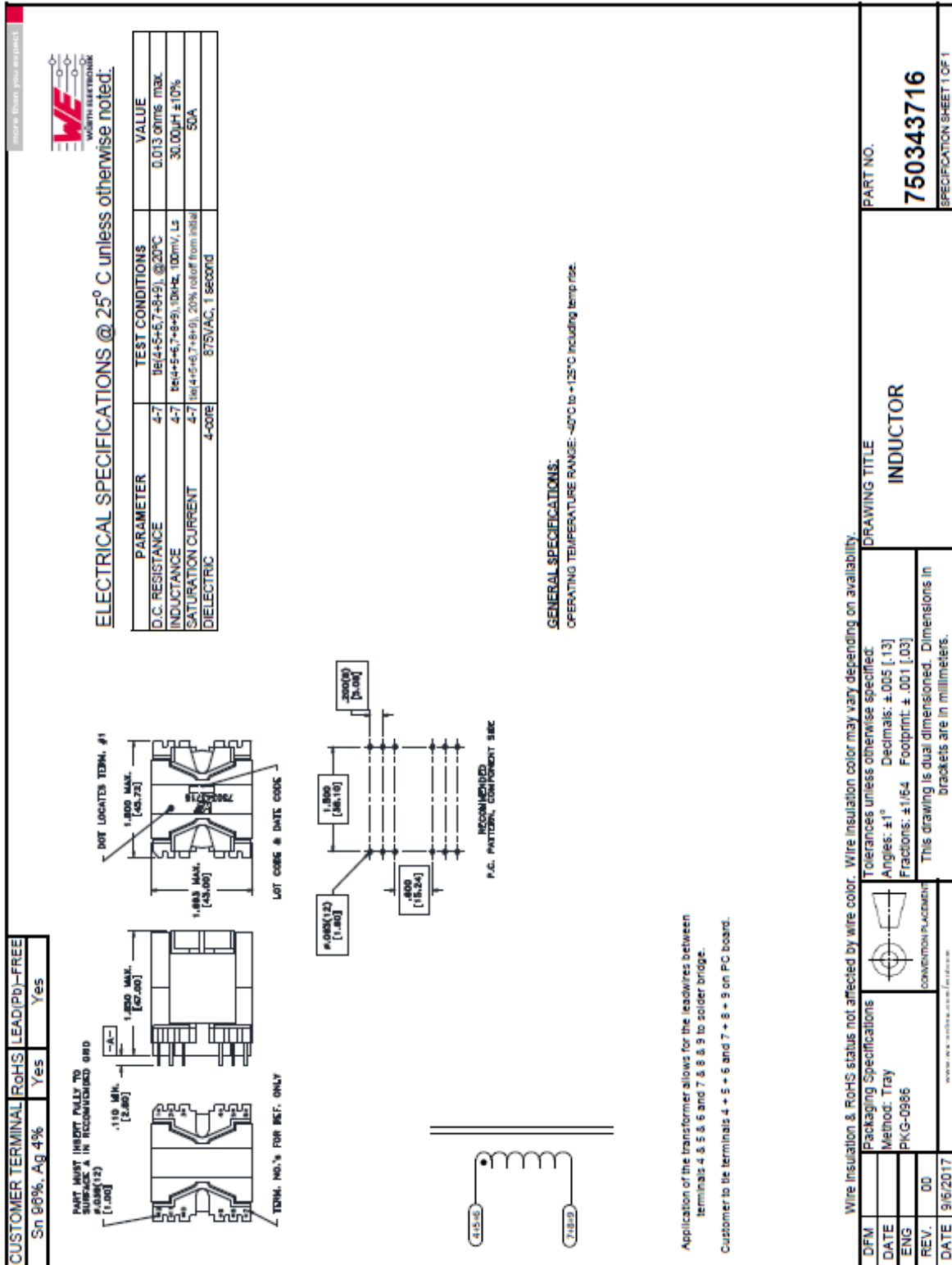

TND6327/D

TEST RESULT

Efficiency of PFC Stage:

Table 3.

TEST CONDITION: 10% LOAD

Vin(Vac)	Pin(W)	PF	Vo(V)	Io(A)	Po(W)	Eff.
90	366.4	0.99	393.5	0.88	346.28	94.51%
110	364.1	0.98	393.58	0.88	346.35	95.13%
220	357.8	0.66	393.38	0.88	346.17	96.75%
264	356.5	0.54	393.24	0.88	346.05	97.07%

TEST CONDITION: 25% LOAD

Vin(Vac)	Pin(W)	PF	Vo(V)	Io(A)	Po(W)	Eff.
90	857.3	0.99	393.47	2.07	814.48	95.01%
110	848.1	0.99	393.48	2.07	814.50	96.04%
220	831.9	0.96	393.61	2.07	814.77	97.94%
264	829.8	0.86	393.66	2.07	814.88	98.20%

TEST CONDITION: 50% LOAD

Vin(Vac)	Pin(W)	PF	Vo(V)	Io(A)	Po(W)	Eff.
90	lin > 16 A, N/A					
110	lin > 16 A, N/A					
220	1743.5	0.99	393.52	4.34	1707.88	97.96%
264	1736	0.98	393.56	4.34	1708.05	98.39%

TEST CONDITION: 75% LOAD

Vin(Vac)	Pin(W)	PF	Vo(V)	Io(A)	Po(W)	Eff.
90	lin > 16 A, N/A					
110	lin > 16 A, N/A					
220	2635.5	0.99	393.51	6.56	2581.43	97.95%
264	2624.7	0.98	393.51	6.57	2585.36	98.50%

TEST CONDITION: 100% LOAD

Vin(Vac)	Pin(W)	PF	Vo(V)	Io(A)	Po(W)	Eff.
90	lin > 16 A, N/A					
110	lin > 16 A, N/A					
220	3507.3	0.99	393.46	8.72	3430.97	97.82%
264	3497.4	0.98	393.45	8.73	3434.82	98.21%

TND6327/D

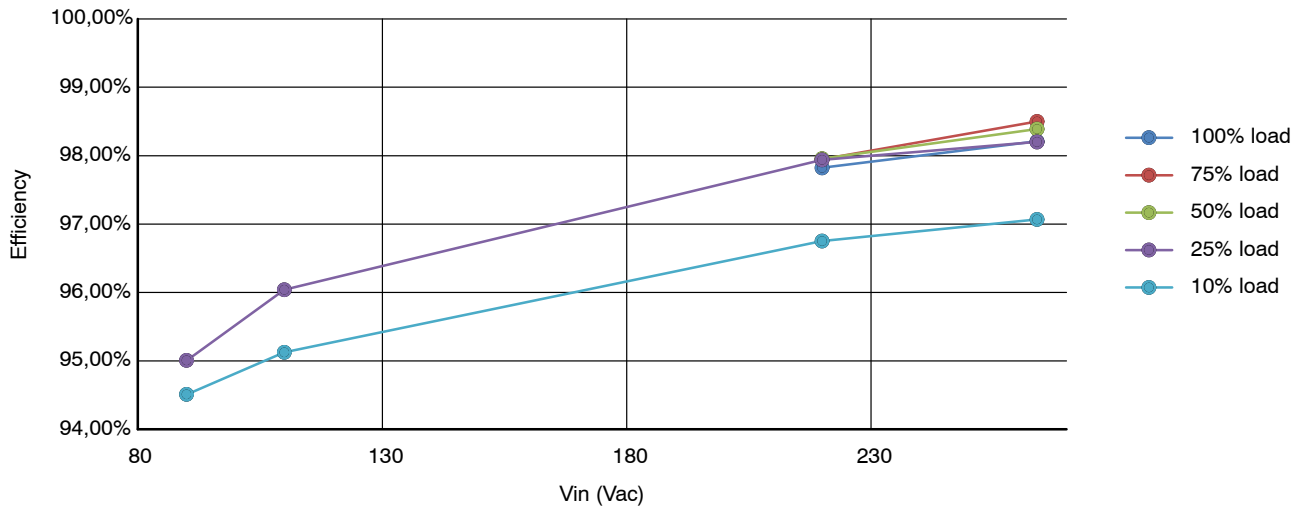

Figure 12. PFC Stage Efficiency vs. Input Voltage

Test waveform: Pink Vds1; Blue Vds2; Green IL

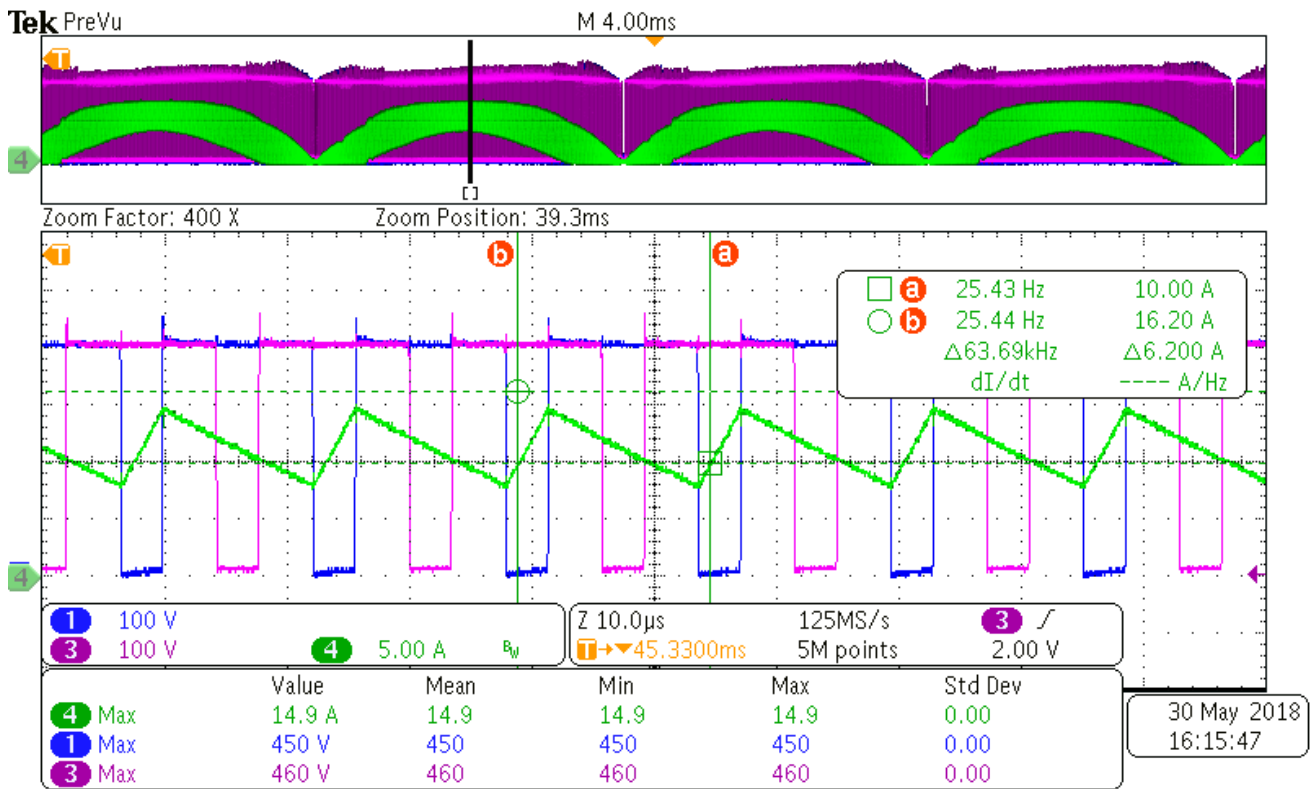

Figure 13. Test Condition: 220 Vac, Full Load

TND6327/D

Efficiency of total set

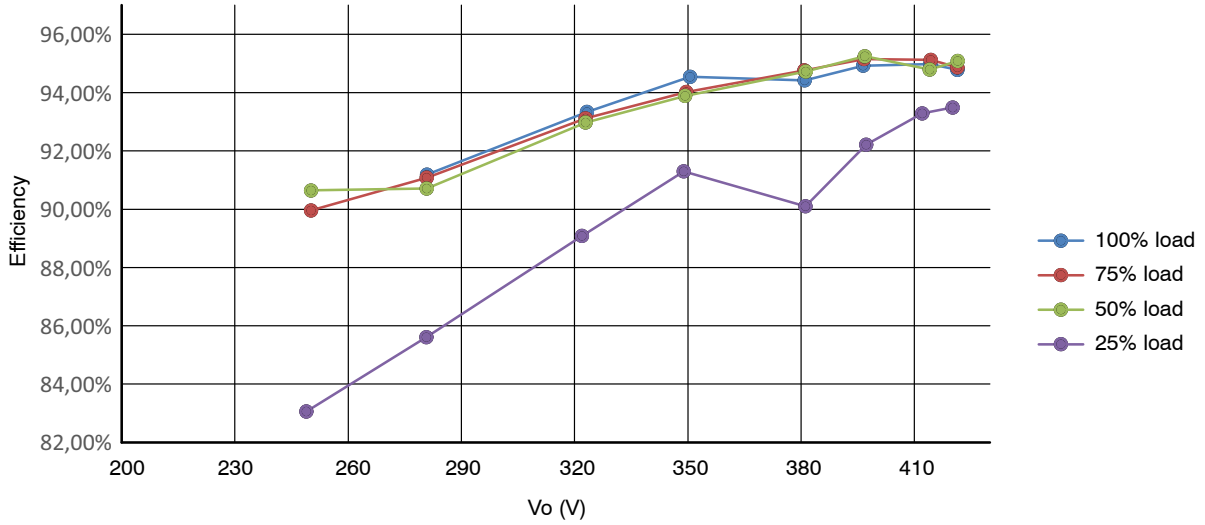

Figure 14. Chart 2 – Efficiency vs. Vo Curve @ Vin = 220 Vac

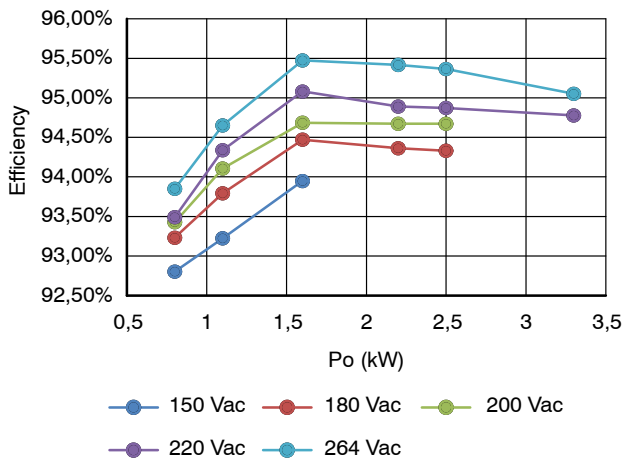

Figure 15. Efficiency vs. Po Curve @ Vo = 420 Vdc

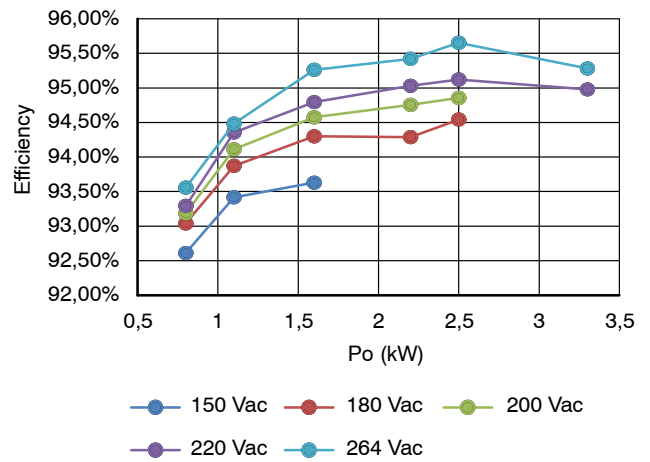

Figure 16. Efficiency vs. Po Curve @ Vo = 410 Vdc

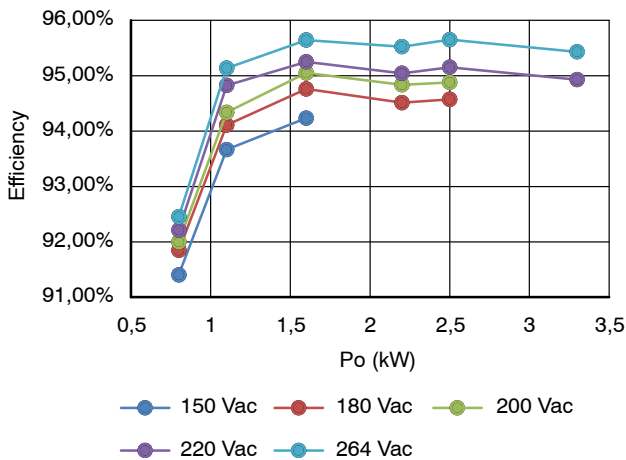

Figure 17. Efficiency vs. Po Curve @ Vo = 400 Vdc

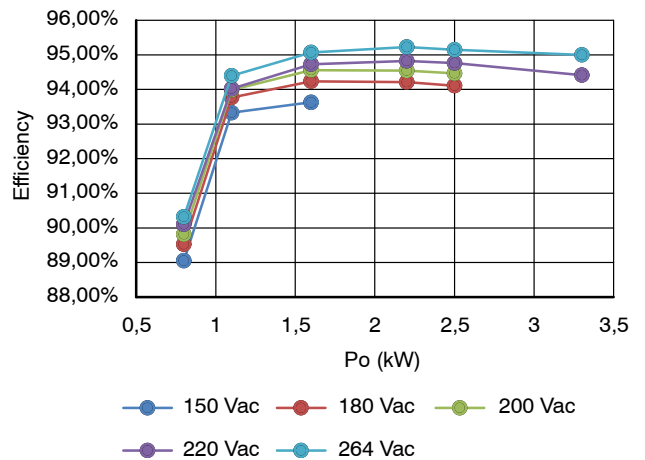

Figure 18. Efficiency vs. Po Curve @ Vo = 380 Vdc

TND6327/D

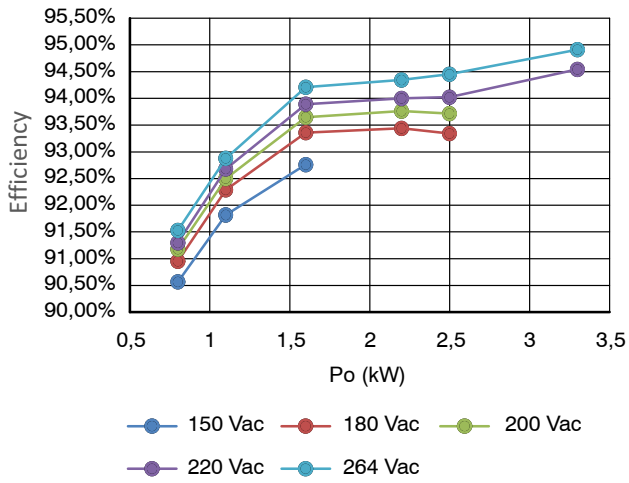

Figure 19. Efficiency vs. Po Curve @ Vo = 350 Vdc

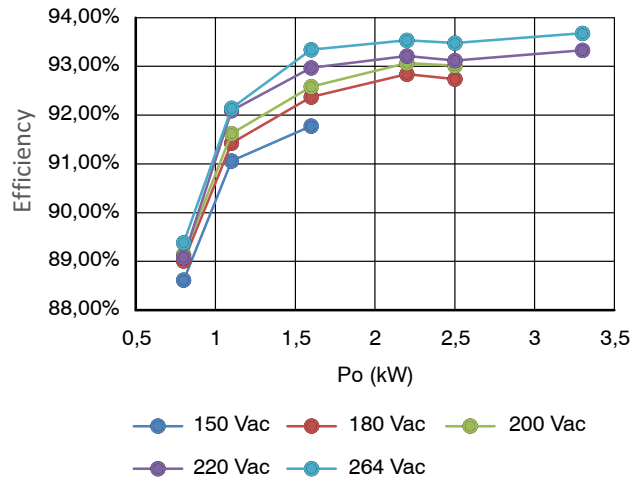

Figure 20. Efficiency vs. Po Curve @ Vo = 320 Vdc

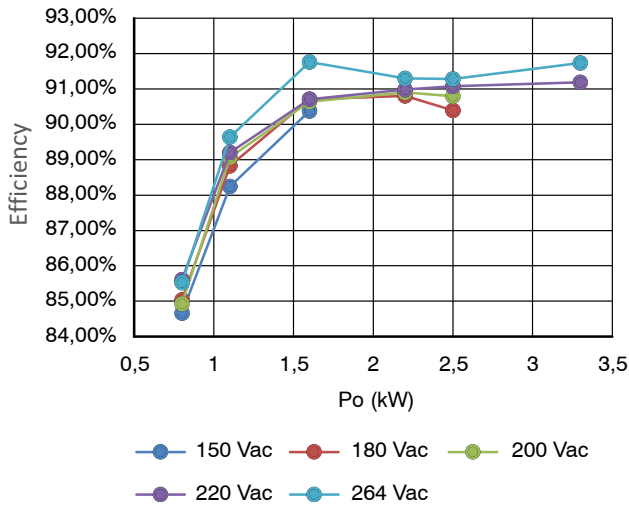

Figure 21. Efficiency vs. Po Curve @ Vo = 280 Vdc

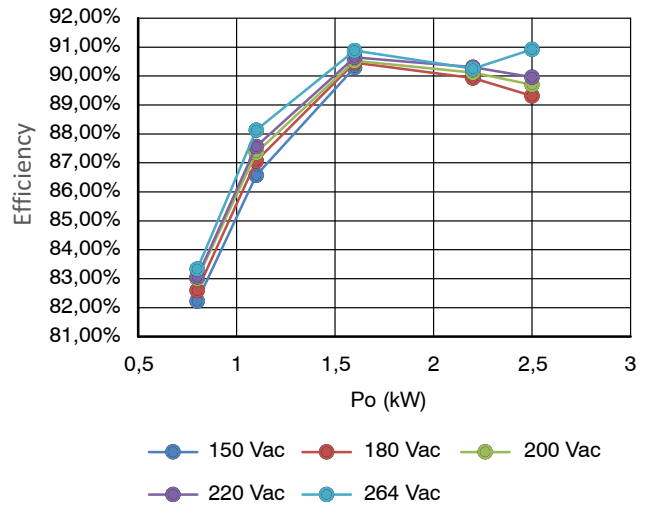

Figure 22. Efficiency vs. Po Curve @ Vo = 250 Vdc

Waveforms of LLC stage. : Green: Current of the resonant tank; Blue: VHB1; Pink: VHB2.

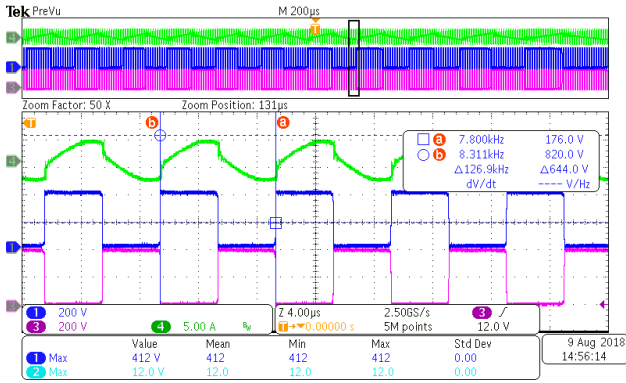

Figure 23. Vo = 400 Vdc, Load = 25%

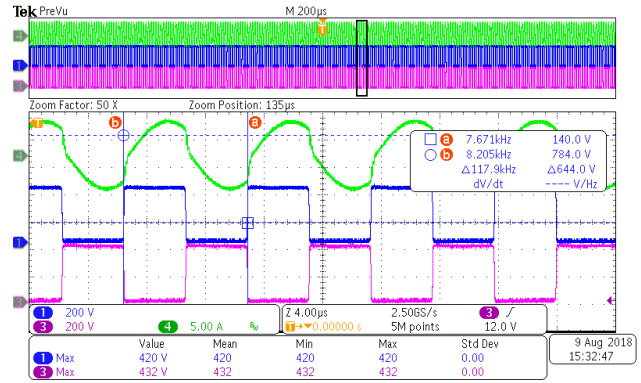

Figure 24. Vo = 400 Vdc, Load = 50%

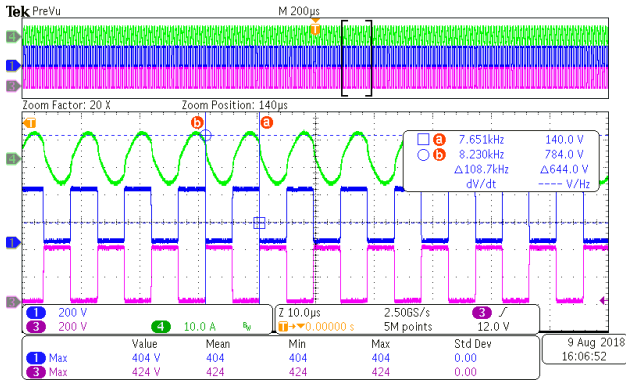

Figure 25. Vo = 400 Vdc, Load = 75%

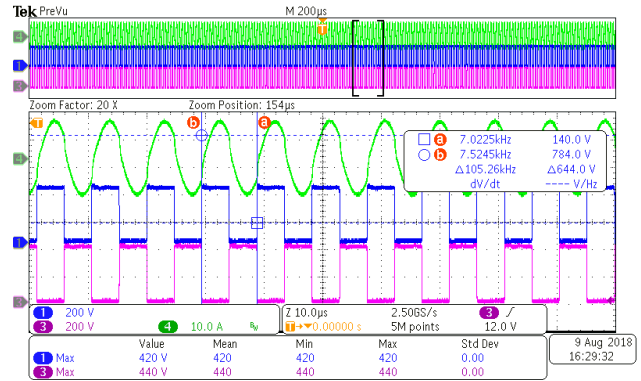

Figure 26. Vo = 400 Vdc, Load = 100%

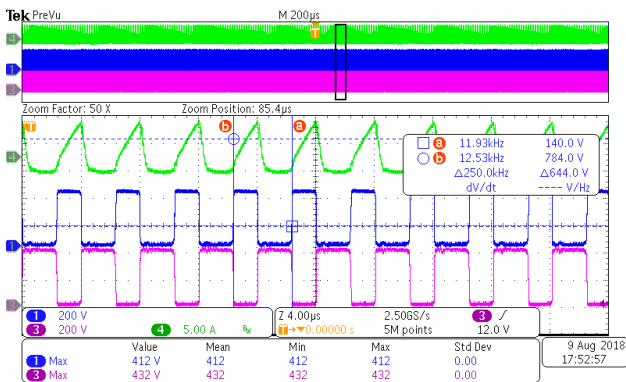

Figure 28. Vo = 350 Vdc, Load = 25%

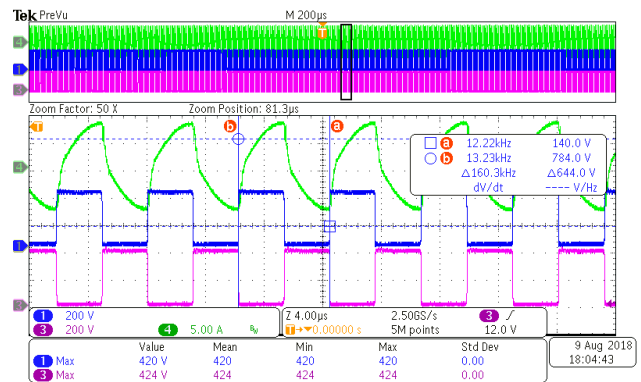

Figure 27. Vo = 350 Vdc, Load = 50%

TND6327/D

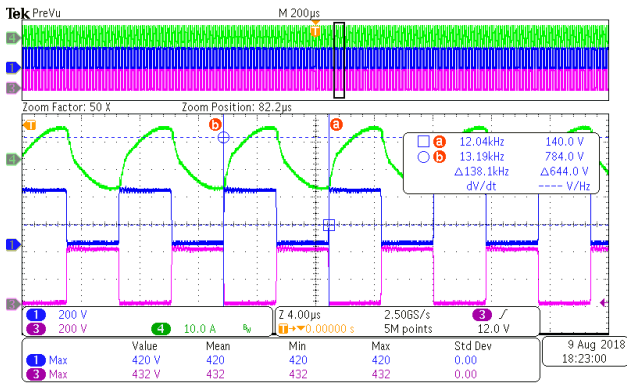

Figure 29. Vo = 350 Vdc, Load = 75%

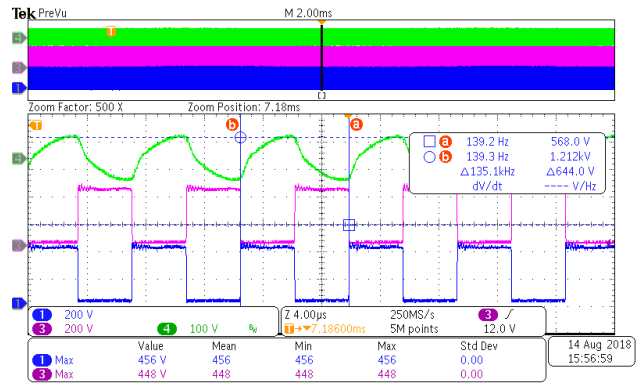

Figure 30. Vo = 350 Vdc, Load = 100%

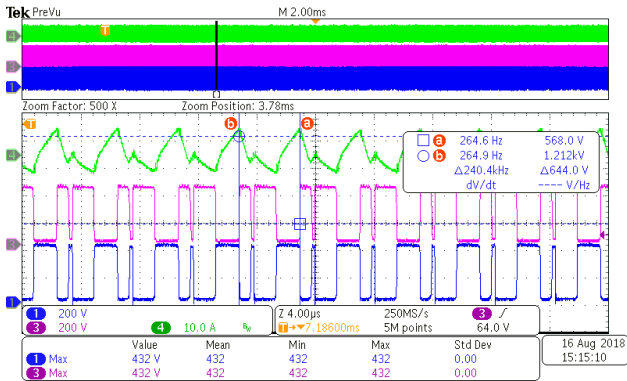

Figure 31. Vo = 250 Vdc, Load = 25%

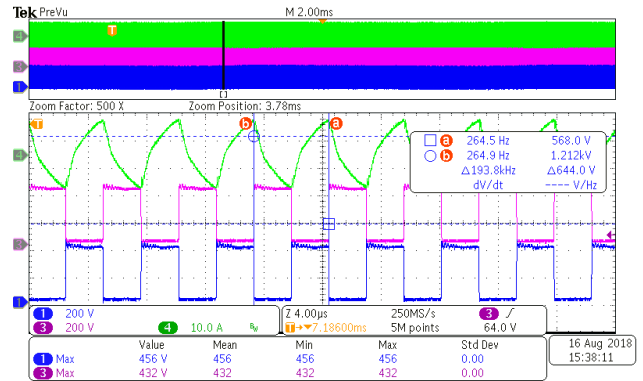

Figure 32. Vo = 250 Vdc, Load = 50%

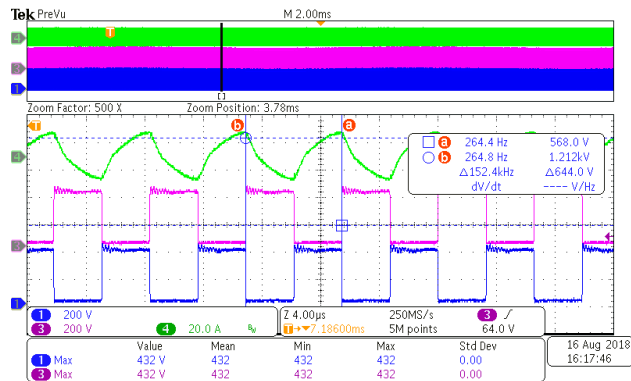

Figure 33. Vo = 250 Vdc, Load = 75%

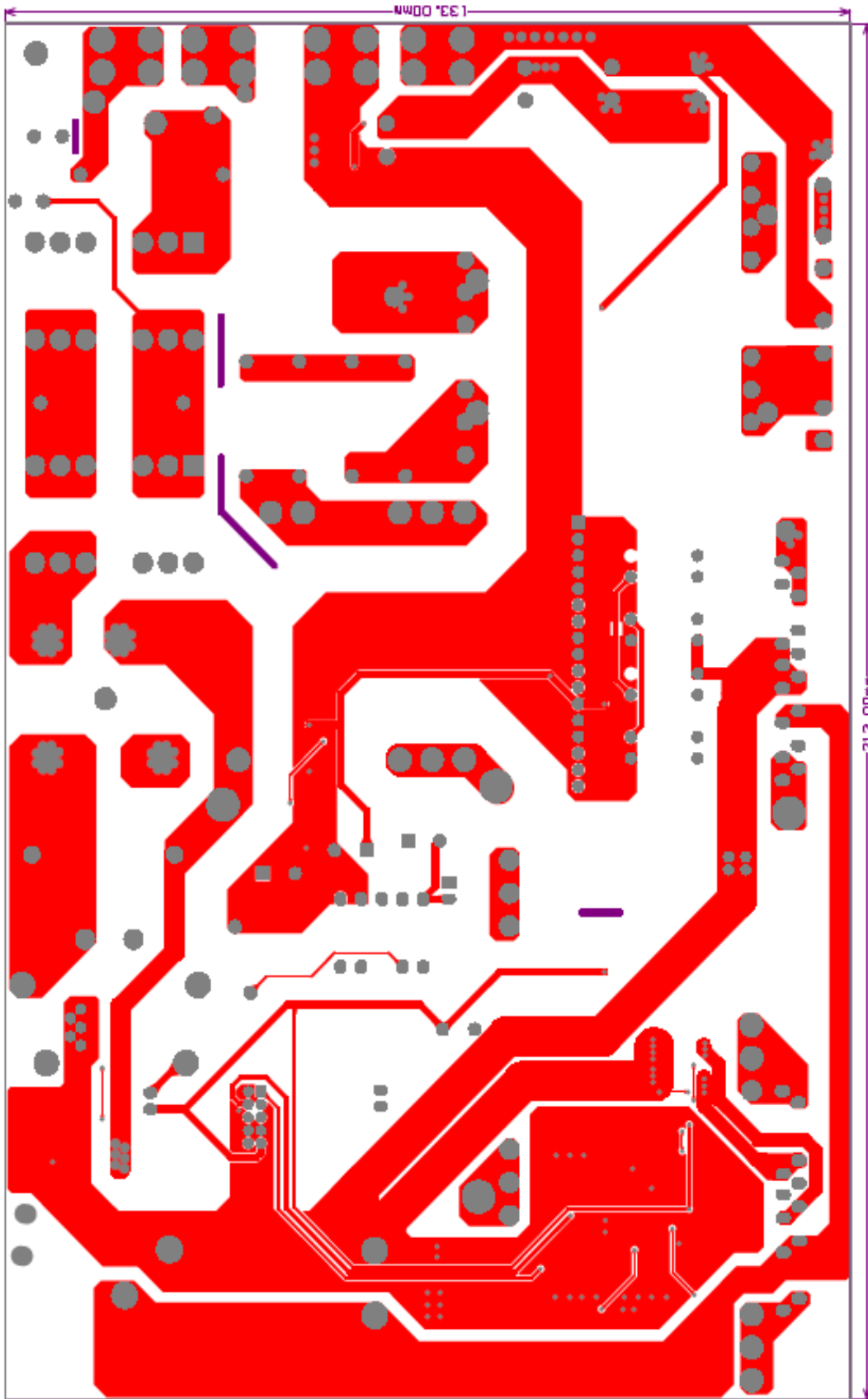

Figure 34. Top Layer of Main Board

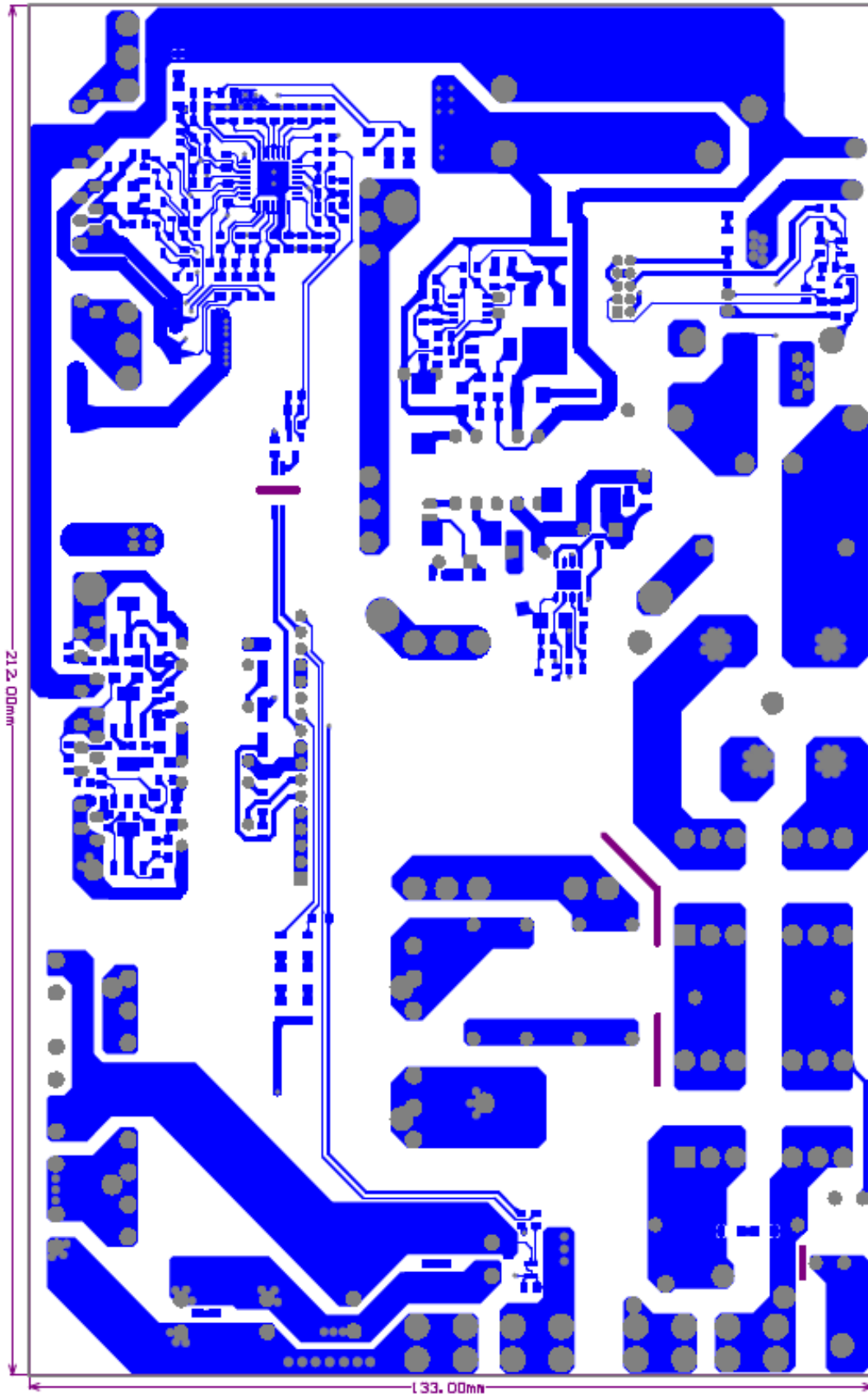

Figure 35. Bottom Layer of Main Board

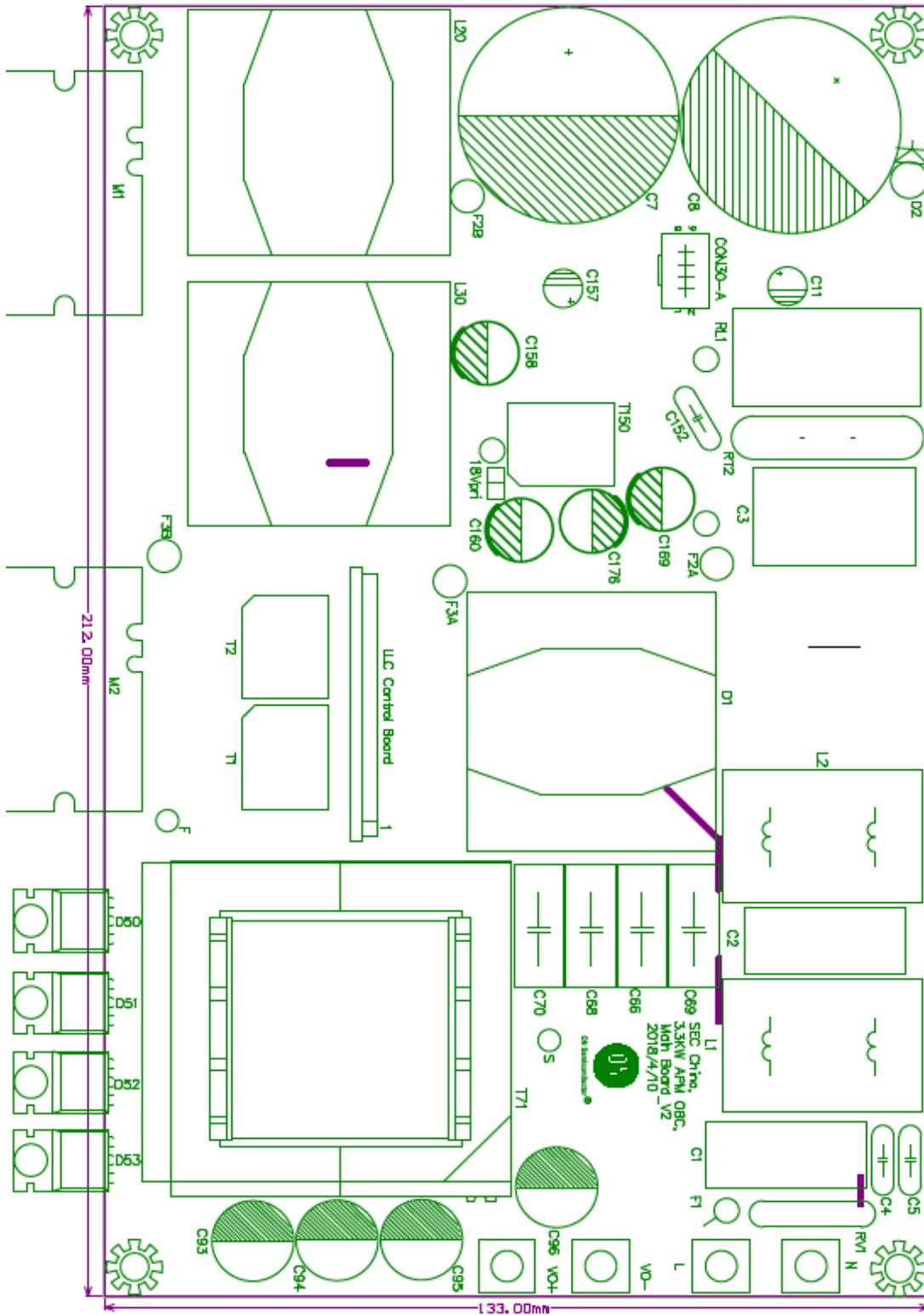

Figure 36. Top Silkscreen

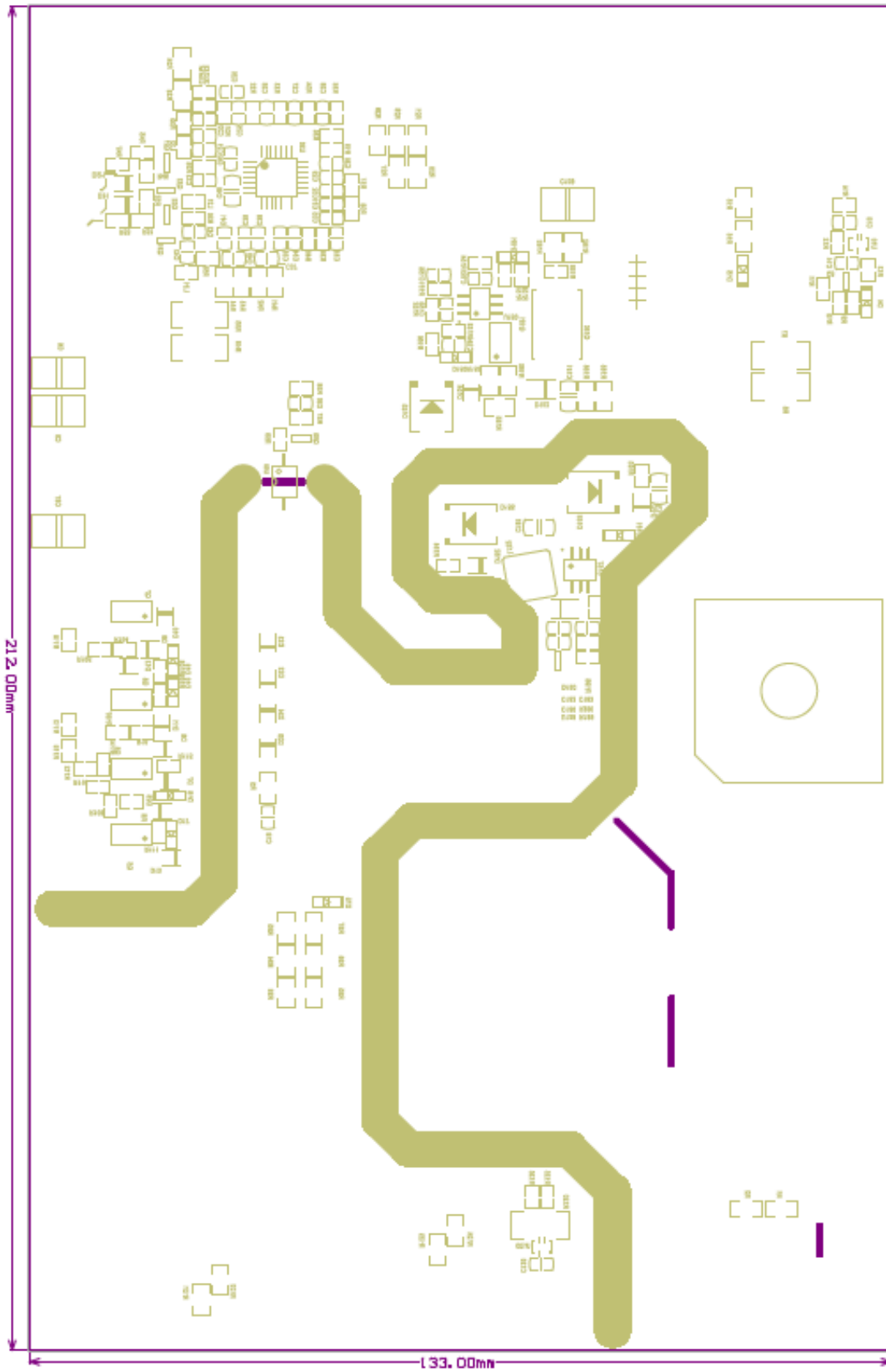

Figure 37. Bottom Silkscreen

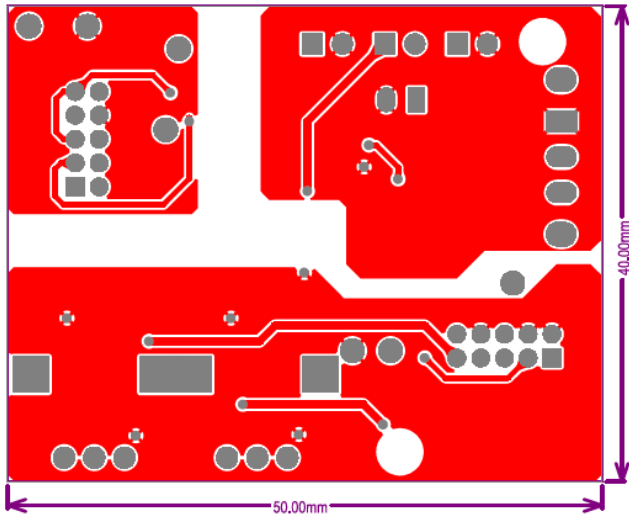

Figure 42. Top Layer of Analog Control Board

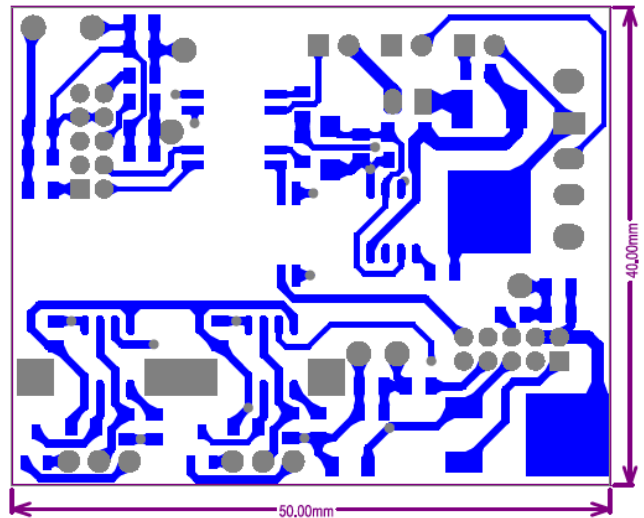

Figure 43. Bottom Layer of Analog Control Board

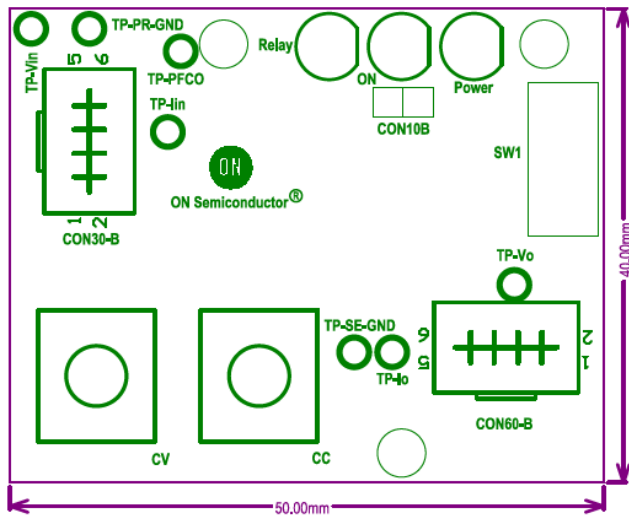

Figure 44. Top Silkscreen

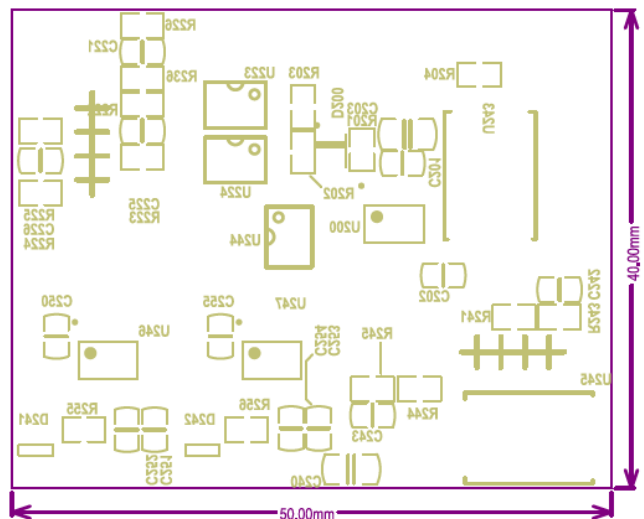

Figure 45. Bottom Silkscreen

TND6327/D

BILL OF MATERIALS

Table 4. MAIN BOARD

Type	Location	Part No.	Description	Manufacturer	Qty	AECQ
E-Cap	C11	860020473010	E-cap, 150 μ F / 25 V, D 6.3 mm * L 11 mm, Pitch = 2.5 mm	Wurth	1	No
E-Cap	C11	EEUFR1E101*	E-cap, 150 μ F / 25 V, D 6.3 mm * L 11 mm, Pitch = 2.5 mm	Panasonic	1	No
E-Cap	C157	860160572003	E-cap, 22 μ F / 35 V, D 5 mm * L 11 mm, Pitch = 2 mm	Wurth	1	No
E-Cap	C157	EEUFC1V220*	E-cap, 22 μ F / 35 V, D 5 mm * L 11 mm, Pitch = 2 mm	Panasonic	1	Yes
E-Cap	C158	860160475027	E-cap, 1000 μ F / 25 V, D 10 mm * L 25 mm, Pitch = 5 mm	Wurth	1	No
E-Cap	C158	EEUFK1E102L*	E-cap, 1000 μ F / 25 V, D 10mm * L 25 mm, Pitch = 5 mm	Panasonic	1	Yes
E-Cap	C160, C169	860160575020	E-cap, 220 μ F / 35 V, D 10 mm * L 12.5 mm, Pitch = 5mm	Wurth	2	No
E-Cap	C160, C169	EEUFC1V221L*	E-cap, 220 μ F / 35 V, D 10 mm * L 12.5 mm, Pitch = 5 mm	Panasonic	2	Yes
E-Cap	C176	860080475017	E-cap, 560 μ F / 25 V, D 10 mm * L 20 mm, Pitch = 5 mm	Wurth	1	
E-Cap	C176	EEUFK1E561*	E-cap, 560 μ F / 25 V, D 10 mm * L 20 mm, Pitch = 5 mm	Panasonic	1	Yes
E-Cap	C7, C8	B43643A5687M57	E-cap, 680 μ F / 450 V, D 35 mm * L 45 mm, Pitch = 10 mm	TDK(EPCOS)	2	
E-Cap	C7, C8	450MXK680MEFCSN35X45	E-cap, 680 μ F / 450 V, D 35 mm * L 45 mm, Pitch = 10 mm	Rubycon	2	
E-Cap	C7, C8		E-cap, 680 μ F / 450 V, D 35 mm * L 47 mm, Pitch = 10 mm	TDK (EPCOS)	2	Yes
E-Cap	C93, C94, C95, C96	EEUEE2E470()	E-cap, 47 μ F / 250 V, D 12.5 mm * L 27 mm, Pitch = 5.08 mm	Panasonic	4	
E-Cap	C93, C94, C95, C96	UCS2E470MHD	E-cap, 47 μ F / 250 V, D 12.5 mm * L 27 mm, Pitch = 5.08 mm	Nichicon	4	
APM	M1	FAM65CR51DZ2	Automotive Power Module for PFC, APM-16	ON Semiconductor	1	Yes
APM	M2	FAM65HR51DS2	Automotive Power Module for LLC, APM-16	ON Semiconductor	1	Yes
BJT	Q3, Q21, Q31	NSS40201LT1G	Transistor, NPN, 40 V, 2 A, SOT-23-3L	ON Semiconductor	3	Yes
BJT	Q22, Q32	NSV40200LT1G	Transistor, PNP, -40 V, 2 A, SOT-23-3L	ON Semiconductor	2	Yes

TND6327/D

Table 4. MAIN BOARD (continued)

Type	Location	Part No.	Description	Manufacturer	Qty	AECQ
BJT	Q5, Q6, Q7, Q8	NJT4030PT1G	Transistor, PNP, -40 V, 3 A, SOT-223	ON Semiconductor	4	Yes
BJT	Q50	SMMBT3904LT1G	Transistor, NPN, 40 V, 0.2 A, SOT-23-3L	ON Semiconductor	1	Yes
Chip Resistor	R154	100	Chip resistor, 0805, 100 Ω		1	
Chip Resistor	R153	100K	Chip resistor, 0805, 100 k Ω		1	
Chip Resistor	R19, R39, R47, R53, R57, R110, R113, R116, R119, R159, R198	10K	Chip resistor, 0805, 100 k Ω		11	
Chip Resistor	R6, R13, R18, R45, R46, R51, R52, R104, R114, R126	10R	Chip resistor, 0805, 10 Ω		10	
Chip Resistor	R33, R34	12.4KF	Chip resistor, 0805, 12.4 k Ω , F		2	
Chip Resistor	R14, R26	12.7KF	Chip resistor, 0805, 12.7 k Ω , F		2	
Chip Resistor	R30, R37, R38	18K	Chip resistor, 0805, 18 k Ω		3	
Chip Resistor	R9, R10	1K	Chip resistor, 0805, 1 k Ω		2	
Chip Resistor	R105, R107, R108, R112	1R	Chip resistor, 0805, 1 Ω		4	
Chip Resistor	R59	2.2K	Chip resistor, 0805, 2.2 k Ω		1	
Chip Resistor	R200	1.2K	Chip resistor, 0805, 1.2 k Ω , F		1	
Chip Resistor	R22	200K	Chip resistor, 0805, 200 k Ω		1	
Chip Resistor	R50, R56	220R	Chip resistor, 0805, 220 Ω		2	
Chip Resistor	R157	22R	Chip resistor, 0805, 22 Ω		1	
Chip Resistor	R150	24K	Chip resistor, 0805, 24 k Ω		1	
Chip Resistor	R199	82R	Chip resistor, 0805, 82 Ω , F		1	
Chip Resistor	R31	33K	Chip resistor, 0805, 33 k Ω		1	
Chip Resistor	R23	36K	Chip resistor, 0805, 36 k Ω		1	
Chip Resistor	R32	39K	Chip resistor, 0805, 39 k Ω		1	
Chip Resistor	R36, R125, R151	4.75KF	Chip resistor, 0805, 4.75 k Ω , F		3	
Chip Resistor	R41, R42, R43, R44	470R	Chip resistor, 1206, 470 Ω		4	
Chip Resistor	R40	47K	Chip resistor, 0805, 47 k Ω		1	
Chip Resistor	R106, R109, R111, R115, R152, R158	47R	Chip resistor, 0805, 47 Ω		6	
Chip Resistor	R11, R12, R35	8.2K	Chip resistor, 0805, 8.2 k Ω		3	
Chip Resistor	R193, R194	82R	Chip resistor, 0805, 82 Ω		2	
Chip Resistor	R58	NC	NC		1	
Chip Resistor	R155, R156, R165, R166	470K	Chip resistor, 0805, 470 k Ω		4	
Chip Resistor	R5	1R//1R	Chip resistor, 1206, 0.5 Ω		1	
Chip Resistor	R162, R163	2.2	Chip resistor, 1206, 2.2 Ω		2	
Chip Resistor	R121, R122, R123, R124	220K	Chip resistor, 1206, 220 k Ω		4	

TND6327/D

Table 4. MAIN BOARD (continued)

Type	Location	Part No.	Description	Manufacturer	Qty	AECQ
Chip Resistor	R1, R2, R15, R16, R20, R21, R24, R25	1M	Chip resistor, 1206, 1 M Ω		8	
Chip Resistor	R27, R28, R29	2M	Chip resistor, 1206, 2 M Ω , F		3	
Chip Resistor	R93, R94, R95	330K	Chip resistor, 1206, 330 k Ω		3	
Chip Resistor	R160	4.7K	Chip resistor, 1206, 4.7 k Ω		1	
Chip Resistor	R65, R66, R67	750K	Chip resistor, 1206, 750 k Ω		3	
Chip Resistor	R7, R8, R120	2mR/2512	Chip resistor, 2512, 2 m Ω , 2 W		3	
Chip Resistor	R49, R55	20mR/2512	Chip resistor, 2512, 20 m Ω , 2 W		2	
Chip Resistor	R49, R55	30mR/2512	Chip resistor, 2512, 30 m Ω , 2 W		2	
Diode	D1	GBPC3506W	Bridge rectifier, 35 A, 600 V, GBPC	ON Semiconductor	1	
Diode	D152	NRVA4007T3G	Power Rectifier, Standard Re- covery, 1 A, 1000 V, SMA	ON Semiconductor	1	Yes
Diode	D153, D155, D156	NRVBS3100T3G	Schottky Power Rectifier, Surface Mount, 3.0 A, 100 V, SMC	ON Semiconductor	3	Yes
Diode	D154	SZMMSZ15T1G	Zener diode, 15 V, 500 mW, SOD-123FL	ON Semiconductor	1	Yes
Diode	D157, D162	SZMMSZ22T1G	Zener diode, 22V, 500mW, SOD-123FL	ON Semiconductor	2	Yes
Diode	D160	NRVBA340T3G	Schottky Power Rectifier, Surface Mount, 3.0 A, 40 V, SMA	ON Semiconductor	1	Yes
Diode	D2	SURS8360T3G	Power Rectifier, Ultra-Fast Recovery, 3 A, 600 V, SMC	ON Semiconductor	1	Yes
Diode	D4, D15, D16, D17, D18, D19, D75, D150, D151, D161	SBAS16HT1G	Switching Diode, 0.2 A, 100 V, SOD-323	ON Semiconductor	10	Yes
Diode	D50, D51, D52, D53	FFSP3065A	SiC Diode, 30 A, 650 V, TO-220-2	ON Semiconductor	4	
Diode	D7, D8, D9, D10, D11, D12, D13, D21, D22, D23, D24, D25, D26, D31	NRVB120ESFT1G	Schottky Power Rectifier, Surface Mount, 1.0 A, 20 V, SOD-123FL	ON Semiconductor	14	Yes
Film Cap	C3	ECWFE2J225K	Film cap, 2.2 μ F, 630 V, L 26 * T 16 * H 23, pitch = 22.5 mm	Panasonic	1	Yes
Film Cap	C66, C69	ECWHA3C473J	Film cap, 47 nF, 1600 V, pitch = 22.5 mm	Panasonic	2	
Fuse	F1	0505030.MXEP	Fuse, 30 A	Littlefuse	1	
Wire	18Vpri	Wire connected to CON10B	Wire, AWG20, Red and black wire, L = 25 cm		1	
Header	CON30-A	5 * 2 pin, 2 mm	PHB2.0, 2 X 5 pin	BOOMELE	1	
Wire	F, S		Flying wire from Current transformer		2	
Wire	F2A, F2B, F3A, F3B		Flying wire to connect F2A & F2B, F3A & F3B, 5AWG		2	

TND6327/D

Table 4. MAIN BOARD (continued)

Type	Location	Part No.	Description	Manufacturer	Qty	AECQ
IC	U10, U120	NCV210RSQT2G	Current Sense Amplifier, 26 V, Low-/High-Side Voltage Out, Bidirectional Current Shunt Monitor, SC70-6	ON Semiconductor	2	Yes
IC	U150	NCV3843BVD1R2G	Current Mode PWM Controller, SOIC8	ON Semiconductor	1	Yes
IC	U157	NCV890100PDR2G	Automotive Switching Regulator, Buck, 1.2 A, 2 MHz, SOIC8-EP	ON Semiconductor	1	Yes
IC	U159	NCV51460SN33T1G	Precision Voltage Reference, 20 mA Micropower, 3.3 V, SOT-23-3	ON Semiconductor	1	Yes
IC	U20	FAN9672Q	Power Factor Controller (PFC), Interleaved Two-Channel, CCM, LQFP-32	ON Semiconductor	1	
Inductor	L1, L2	7448053201	1 mH / 25 A	Würth	2	
Inductor	L152	SPM7045VT-220M-D	SMT inductor, 7 * 7 * 4.5, 22 µH, 1.7 A	TDK	1	Yes
Inductor	L20, L30	750343941	PFC Inductor, PQ4040, 150 µH	Würth	2	
Inductor	L21, L22, L31	TFM201610ALMA1R0MTAA	SMT 2016, 1 µH	TDK	3	Yes
MLCC	C10	NC	NC	NC	0	
MLCC	C14, C22, C120, C154, C180, C182	885012207072	MLCC, 0805, 104, 25 V	Würth	6	
MLCC	C14, C22, C120, C154, C180, C182	CGA4J2X7R2A104K125AA	MLCC, 0805, 104, 100 V	TDK	6	Yes
MLCC	C151	CGA5H4X7R2J222K115AA	MLCC, 1206, 222, 630 V	TDK	1	Yes
MLCC	C179	885012208094	MLCC, 1206, 475, 50 V	Würth	1	
MLCC	C18	885012107018	MLCC, 0805, 475, 25 V	Würth	1	
MLCC	C18	CGA4J3X7R1C475K125AB	MLCC, 0805, 475, 16 V	TDK	1	Yes
MLCC	C20	885012207096	MLCC, 0805, 473, 50 V	Würth	1	
MLCC	C20	CGA4J2X7R2A473M125AA	MLCC, 0805, 473, 100 V	TDK	1	Yes
MLCC	C21, C42, C43, C92	885012207076	MLCC, 0805, 474, 25 V	Würth	4	
MLCC	C21, C42, C43, C92	CGA4J2X7R1E474K125AA	MLCC, 0805, 474, 25 V	TDK	4	Yes
MLCC	C23, C26, C27, C34	885012007061	MLCC, 0805, 471, 50 V, NP0	Würth	4	
MLCC	C23, C26, C27, C34	CGA4C4C0G2W471J060AA	MLCC, 0805, 471, 450 V, NP0	TDK	4	Yes
MLCC	C24	885012207074	MLCC, 0805, 224, 25 V	Würth	1	
MLCC	C24	CGA4J2X7R1H224K125AA	MLCC, 0805, 224, 25 V	TDK	1	Yes
MLCC	C25, C28, C33, C35, C50, C150	885012207092	MLCC, 0805, 103, 50 V	Würth	6	
MLCC	C25, C28, C33, C35, C50, C150	CGA4C2C0G1H103J060AA	MLCC, 0805, 103, 50 V	TDK	6	Yes
MLCC	C29, C31, C37, C40	885012207086	MLCC, 0805, 102, 50 V	Würth	4	

TND6327/D

Table 4. MAIN BOARD (continued)

Type	Location	Part No.	Description	Manufacturer	Qty	AECQ
MLCC	C29, C31, C37, C40	CGA4C2C0G2A102J060AA	MLCC, 0805, 102, 100 V	TDK	4	Yes
MLCC	C30, C32, C153, C156	885012007057	MLCC, 0805, 101, 50 V, NP0	Würth	4	
MLCC	C30, C32, C153, C156	CGA4C4C0G2W101J060AA	MLCC, 0805, 101, 450 V, NP0	TDK	4	Yes
MLCC	C36, C38, C39, C41, C183	885012207088	MLCC, 0805, 222, 50 V	Würth	5	
MLCC	C36, C38, C39, C41, C183	CGA4C2C0G1H222J060AA	MLCC, 0805, 222, 50 V	TDK	5	Yes
MLCC	C46, C181	885012208069	MLCC, 1206, 106, 25 V	Würth	2	
MLCC	C46, C181	CGA5L1X7R1E106K160AC	MLCC, 1206, 106, 25 V	TDK	2	Yes
MLCC	C6, C9, C67, C159	CKG57NX7T2J105M500JJ	Mega cap, 2220, 105 / 630 V	TDK	4	Yes
Mosfet	Q150	FCD3400N80Z	N-Channel SUPERFET [®] II MOSFET 800 V, 2 A, 3.4 Ω, DPAK-3	ON Semiconductor	1	
Mosfet	Q151	FQT1N60CTF-WS	N-Channel QFET [®] MOSFET 600 V, 0.2 A, 11.5 Ω, SOT-223	ON Semiconductor	1	
Opto-coupler	U50	FODM8801C	OptoHiT Series, High-Temperature Phototransistor, MFP-4	ON Semiconductor	1	
PCB	Main Board		1 Oz, 2 layer, FR4	嘉立創	1	
Relay	RL1	ALF1P12	Relay, 20 A, 250 VAC	Panasonic	1	
Safety Cap	C1, C2	ECQUAAF105K	X2 cap, 1 μF, 275 VAC L 26 mm * T 12 mm * H 19 mm	Panasonic	2	Yes
Safety Cap	C4, C5, C152	CD45-E2GA472M-NKA	Y1 cap, 472	TDK	3	Yes
Terminal	L, N, VO+, VO-	L		Würth	4	
Thermistor	RT2	B57127P0100M301	Thermistor, 10 Ω @ 25 degree, AEC-Q200, D = 31 mm	TDK (EPCOS)	1	Yes
Transformer	T1, T2	EE16	Driver transformer, EE16	Würth	1	
Transformer	T150	EE17	Auxiliary transformer, EE16	Würth	2	
Inductor	T70	PQ4040	Resonant inductor, PQ4040, 30 μH, 30 A	Würth	1	
Transformer	T71	P301039-A1-55	LLC main transformer, PQ50, 280 μH	TDK (EPCOS)	1	
Varistor	RV1	820423211	Varistor, 320 Vac, D = 20 mm	Würth	1	
Varistor	RV1	B72220S2321K101	Varistor, 320 Vac, D = 21.5 mm	TDK (EPCOS)	1	Yes
Spacer		971070385	Spacer stud with metric thread internal / external, M3, L = 7 mm	Würth	4	
Heatsink						

TND6327/D

Table 5. LLC CONTROL BOARD

Type	Location	Part No.	Description	Manufacturer	Qty	AECQ
MLCC	C16	885012208094	MLCC, 1206, 475, 50 V	Wurth	1	
MLCC	C17, C74	885012207053	MLCC, 0805, 475, 16 V	Wurth	2	
MLCC	C17, C74	CGA4J3X7R1C475K125AB	MLCC, 0805, 475, 16 V	TDK	2	Yes
MLCC	C61, C83	885012207086	MLCC, 0805, 102, 50 V	Wurth	2	
MLCC	C61, C83	CGA4C2C0G2A102J060AA	MLCC, 0805, 102, 100 V	TDK	2	Yes
MLCC	C63	885012207076	MLCC, 0805, 474, 25 V	Wurth	1	
MLCC	C63	CGA4J2X7R1E474K125AA	MLCC, 0805, 474, 25 V	TDK	1	Yes
MLCC	C70	885012007051	MLCC, 0805, 10 pF, 50 V, NP0	Wurth	1	
MLCC	C71, C75, C82	885012007061	MLCC, 0805, 471, 50 V, NP0	Wurth	3	
MLCC	C71, C75, C82	CGA4C4C0G2W471J060AA	MLCC, 0805, 471, 50 V, NP0	TDK	3	Yes
MLCC	C72	885012207090	MLCC, 0805, 472, 50 V	Wurth	1	
MLCC	C72	CGA4C2C0G1H472J060AA	MLCC, 0805, 472, 50 V	TDK	1	Yes
MLCC	C73	885012207074	MLCC, 0805, 224, 25 V	Wurth	1	
MLCC	C73	CGA4J2X7R1H224K125AA	MLCC, 0805, 224, 25 V	TDK	1	Yes
MLCC	C76	885012207096	MLCC, 0805, 473, 50 V	Wurth	1	
MLCC	C76	CGA4J2X7R2A473M125AA	MLCC, 0805, 473, 50 V	TDK	1	Yes
MLCC	C77	885012007059	MLCC, 0805, 221, 50 V, NP0	Wurth	1	
MLCC	C77	CGA4C4C0G2W221J060AA	MLCC, 0805, 221, 450 V, NP0	TDK	1	Yes
MLCC	C80, C86	885012207072	MLCC, 0805, 104, 25 V	Wurth	2	
MLCC	C80, C86	CGA4J2X7R2A104K125AA	MLCC, 0805, 104, 100 V	TDK	2	Yes
MLCC	C81	885012207092	MLCC, 0805, 103, 50 V	Wurth	1	
MLCC	C81	CGA4C2C0G1H103J060AA	MLCC, 0805, 103, 50 V	TDK	1	Yes
MLCC	C84, C91	885012207079	MLCC, 0805, 225, 25 V	Wurth	2	
MLCC	C84, C91	CGA4J3X7R1E225K125AB	MLCC, 0805, 225, 25 V	TDK	2	Yes
MLCC	C85, C90	NC	NC		2	
Header	CON60-A	5*2pin, 2.54mm	Connector, PHB2.0 - 2 x 5 pin	BOOMELE	1	
Diode	D76	SBAS16HT1G	Switching Diode, 0.2 A, 100 V, SOD-323	ON Semiconductor	1	Yes
Header	H5	Comment			1	
BJT	Q1, Q9	MJD200T4G	Transistor, NPN, 5 A, 25 V, DPAK-3	ON Semiconductor	2	
BJT	Q2, Q4	NJVMJD210T4G	Transistor, PNP, 5 A, 25 V, DPAK-3	ON Semiconductor	2	Yes
BJT	Q63	NSV40200LT1G	Transistor, PNP, -40 V, 2 A, SOT-23-3L	ON Semiconductor	1	Yes
Mosfet	Q80, Q90	2N7002	N-MOSFET, 0.115 A, 60 V, 7.5 Ω, SOT-23-3L	ON Semiconductor	2	
Chip Resistor	R3, R4, R100, R101	1K	Chip Resistor, 0805, 1 kΩ		4	
Chip Resistor	R60, R61, R86	2.2K	Chip Resistor, 0805, 2.2 kΩ		3	
Chip Resistor	R68	0	Chip Resistor, 0805, 0 Ω		1	
Chip Resistor	R69, R75, R81, R84, R85, R90	10K	Chip Resistor, 0805, 10 kΩ		6	
Chip Resistor	R70	18K	Chip Resistor, 0805, 18 kΩ		1	

TND6327/D

Table 5. LLC CONTROL BOARD (continued)

Type	Location	Part No.	Description	Manufacturer	Qty	AECQ
Chip Resistor	R71	5.1K	Chip Resistor, 0805, 5.1 k Ω		1	
Chip Resistor	R72	36K	Chip Resistor, 0805, 36 k Ω		1	
Chip Resistor	R73	200K	Chip Resistor, 0805, 200 k Ω		1	
Chip Resistor	R74	15K	Chip Resistor, 0805, 15 k Ω		1	
Chip Resistor	R76	NC	NC		1	
Chip Resistor	R77	68K	Chip Resistor, 0805, 68 k Ω		1	
Chip Resistor	R78	12K	Chip Resistor, 0805, 12 k Ω		1	
Chip Resistor	R79, R98	100K	Chip Resistor, 0805, 100 k Ω		2	
Chip Resistor	R80	10R	Chip Resistor, 0805, 10 Ω		1	
Chip Resistor	R82, R83, R89, R91, R92	4.75KF	Chip Resistor, 0805, 4.75 k Ω , F		5	
Chip Resistor	R87	3K	Chip Resistor, 0805, 3 k Ω		1	
Chip Resistor	R88, R96	33K	Chip Resistor, 0805, 33 k Ω		2	
Chip Resistor	R97	68R	Chip Resistor, 0805, 68 Ω		1	
Transformer	T72	EE8	Current sense transformer, EE8		1	
IC	U1	FAN3224TUMX-F085	Dual 4-A High-Speed, Low-Side Gate Drivers	ON Semiconductor	1	Yes
IC	U60	FAN7688SJX	Advanced Secondary Side LLC Resonant Converter Controller with Synchronous Rectifier Control, SOP-16	ON Semiconductor	1	
IC	U80	NCV2003SN2T1G	Operational Amplifier, High Slew Rate, Low Voltage, Rail-to-Rail Output, SOT-23-5L	ON Semiconductor	1	Yes
IC	U81	SC431AVSNT1G	Voltage Reference, Low Cathode Current, Programmable, Shunt Regulator, SOT-23-3	ON Semiconductor	1	Yes

Table 6. ANALOG CONTROL BOARD

Type	Location	Part No.	Description	Manufacturer	Qty	AECQ
MLCC	C201, C250, C255	885012207072	MLCC, 0805, 104, 25 V	Wurth	3	
MLCC	C201, C250, C255	CGA4J2X7R2A104K125AA	MLCC, 0805, 104, 25 V	TDK	3	Yes
MLCC	C202, C251, C253	885012207092	MLCC, 0805, 103, 50 V	Wurth	3	
MLCC	C202, C251, C253	CGA4C2C0G1H103J060AA	MLCC, 0805, 103, 50 V	TDK	3	Yes
MLCC	C203, C240	885012208069	MLCC, 1206, 106, 25 V	Wurth	1	
MLCC	C203, C240	CGA5L1X7R1E106K160AC	MLCC, 1206, 106, 25 V	TDK	1	Yes
MLCC	C221, C225, C226, C242, C243	885012207086	MLCC, 0805, 102, 50 V	Wurth	5	
MLCC	C221, C225, C226, C242, C243	CGA4C2C0G2A102J060AA	MLCC, 0805, 102, 100 V	TDK	5	Yes
MLCC	C252, C254	885012207088	MLCC, 0805, 222, 50 V	Wurth	2	

TND6327/D

Table 6. ANALOG CONTROL BOARD (continued)

Type	Location	Part No.	Description	Manufacturer	Qty	AECQ
MLCC	C252, C254	CGA4C2C0G1H222J060AA	MLCC, 0805, 222, 50 V	TDK	2	Yes
Potentiometer	CC, CV	50K	Potentiometer, 50K		2	
Wire	CON10B	Wire connected to 18Vpri	Wire, AWG20, Red and black wire, L = 25 cm		1	
Header	CON30-B, CON60-B	5 * 2 pin, 2.54 mm	Connector, PHB2.0 – 2 x 5 pin	BOOMELE	2	
Doide	D200	SBAS16HT1G	Switching Diode, 0.2 A, 100 V, SOD-323, SOD-123FL	ON Semiconductor	1	Yes
Doide	D241, D242	SBAV99LT3G	Switching Diode, dual series, 0.215 A, 100 V, SOT-23-3	ON Semiconductor	2	Yes
Hole	H5, H11, H12	Comment			3	
LED	ON	151051RS11000	LED, Red, D = 5 mm	Würth	1	
LED	Power, Relay	151051VS04000	LED, Green, D = 5 mm	Würth	2	
Chip Resistor	R201	150K	Chip resistor, 0805, 150 k Ω		1	
Chip Resistor	R202, R255, R256	1K	Chip resistor, 0805, 1 k Ω		3	
Chip Resistor	R203, R204	2.2K	Chip resistor, 0805, 2.2 k Ω		2	
Chip Resistor	R222, R224	2.43K	Chip resistor, 0805, 2.43 k Ω , F		2	
Chip Resistor	R223, R225, R226, R243, R244, R245	12.4K	Chip resistor, 0805, 12.4 k Ω , F		6	
Chip Resistor	R236, R241	100K	Chip resistor, 0805, 100 k Ω		2	
Switch	SW1	ON	Switch, SW-12D10		1	
Test point	TP-lin	PAD			1	
Test point	TP-Io, TP-PFCO, TP-PR-GND, TP-SE-GND, TP-Vin, TP-Vo	test			6	
IC	U200, U246, U247	NCV1455BDR2G	Timer Circuit, SOIC8	ON Semiconductor	3	Yes
Opto-coupler	U223, U224, U244	FODM8801C	OptoHiT Series, High-Temperature Phototransistor, SSOP4	ON Semiconductor	3	
IC	U243	NCV78M12BDTRKG	Linear Voltage Regulator, Positive, 12 V, 500 mA, DPAK-3	ON Semiconductor	1	Yes
IC	U245	NCV78M05BDTRKG	Linear Voltage Regulator, Positive, 5 V, 500 mA, DPAK-3	ON Semiconductor	1	Yes

SUPERFET and QFET are registered trademarks of Semiconductor Components Industries, LLC (SCILLC) or its subsidiaries in the United States and/or other countries.

ON Semiconductor and  are trademarks of Semiconductor Components Industries, LLC dba ON Semiconductor or its subsidiaries in the United States and/or other countries. ON Semiconductor owns the rights to a number of patents, trademarks, copyrights, trade secrets, and other intellectual property. A listing of ON Semiconductor's product/patent coverage may be accessed at www.onsemi.com/site/pdf/Patent-Marking.pdf. ON Semiconductor reserves the right to make changes without further notice to any products herein. ON Semiconductor makes no warranty, representation or guarantee regarding the suitability of its products for any particular purpose, nor does ON Semiconductor assume any liability arising out of the application or use of any product or circuit, and specifically disclaims any and all liability, including without limitation special, consequential or incidental damages. Buyer is responsible for its products and applications using ON Semiconductor products, including compliance with all laws, regulations and safety requirements or standards, regardless of any support or applications information provided by ON Semiconductor. "Typical" parameters which may be provided in ON Semiconductor data sheets and/or specifications can and do vary in different applications and actual performance may vary over time. All operating parameters, including "Typicals" must be validated for each customer application by customer's technical experts. ON Semiconductor does not convey any license under its patent rights nor the rights of others. ON Semiconductor products are not designed, intended, or authorized for use as a critical component in life support systems or any FDA Class 3 medical devices or medical devices with a same or similar classification in a foreign jurisdiction or any devices intended for implantation in the human body. Should Buyer purchase or use ON Semiconductor products for any such unintended or unauthorized application, Buyer shall indemnify and hold ON Semiconductor and its officers, employees, subsidiaries, affiliates, and distributors harmless against all claims, costs, damages, and expenses, and reasonable attorney fees arising out of, directly or indirectly, any claim of personal injury or death associated with such unintended or unauthorized use, even if such claim alleges that ON Semiconductor was negligent regarding the design or manufacture of the part. ON Semiconductor is an Equal Opportunity/Affirmative Action Employer. This literature is subject to all applicable copyright laws and is not for resale in any manner.

PUBLICATION ORDERING INFORMATION

LITERATURE FULFILLMENT:

Email Requests to: orderlit@onsemi.com

ON Semiconductor Website: www.onsemi.com

TECHNICAL SUPPORT

North American Technical Support:
Voice Mail: 1 800-282-9855 Toll Free USA/Canada
Phone: 011 421 33 790 2910

Europe, Middle East and Africa Technical Support:
Phone: 00421 33 790 2910

For additional information, please contact your local Sales Representative